



OWNER'S MANUAL

BENETEAU 393

HULL IDENTIFICATION NUMBER:
US-BEY _ _ _ _ _

OWNER'S MANUAL BENETEAU PART #: 00990168

SUMMARY:

- I) INTRODUCTION 3
- II) ANTI-FOULING 4
- III) WARRANTY 5
- IV) HULL IDENTIFICATION NUMBERS 7
- V) DEALER'S RESPONSIBILITIES 7
- VI) OWNER'S/OPERATOR'S RESPONSIBILITIES 8
- VII) SAFE OPERATION AND WARNING LABELS 12
- VIII) FEDERAL REGULATIONS 17
- IX) COMMISSIONING 20
- X) SPECIFICATIONS OF THE BOAT 23
- XI) INTERIOR LAYOUT 25
- XII) DECK 27
- XIII) SAILS AND RIGGING 28
- XIV) FRESH WATER SYSTEM 38
- XV) BILGE PUMP SYSTEM 40
- XVI) SEACOCKS AND THRU-HULLS 42
- XVII) ELECTRIC SYSTEMS 44
- XVIII) LP GAS SYSTEM 55
- XIX) EMERGENCY STEERING SYSTEM 57
- XX) ENGINE 58
- XXI) HANDLING 61
- XXII) MAINTENANCE 62
- XXIII) WINTERIZING PROCEDURES 68
- XXIV) ENVIRONMENT 73

EXPLANATION OF THE TYPOGRAPHY USED:

DANGER

WARNING

TAKE CARE

RECEIPT

OWNER'S NAME

ADDRESS

.....

.....

Owner of the BENETEAU 393 number

Do certify that I have accepted delivery and read the information in the owner's manual delivered with the boat.

On

Signature

Please keep this copy for your records



RECEIPT

OWNER'S NAME :

ADDRESS :

.....

.....

Owner of the BENETEAU 393 number

Do certify that I have taken delivery and read the information in the owner's manual delivered with the boat.

On

Signature

Please send back this copy to BENETEAU USA
After Sales Dept
1313 W Hwy 76
Marion, SC 29571
U.S.A.

I) INTRODUCTION

Many parts and systems installed on your boat are supplied by other manufacturers and each carries a specific warranty and may require specific care. This manual supplements the literature supplied with the various equipment and we will refer to manufacture's literature throughout this booklet. We recommend referring to original manufacturer's literature whenever possible.

This manual is broken down into several sections to help explain your boat, your warranty, responsibilities as an owner, and maintenance of your new Beneteau. The systems and procedures described in this manual were correct to the best of our knowledge at the time of printing and may be changed at any time or may have been changed on your boat. While we have tried to describe the major points of your boat within this book, we cannot cover every detail. Please call your dealer or feel free to call us if any question should arise.

Should you need to contact Beneteau please use the following addresses and numbers, be sure to include your model and hull number with any correspondence.

Beneteau Customer Service

(Customer Service Dept.)

1313 Highway 76 West

P.O. Drawer 1218

Marion, SC 29571

Tel (843)-423-6459

Fax (843)-423-5516

Beneteau USA Inc.

(Sales & Marketing)

24 North Market Street, Suite 201

Charleston, SC 29401

Tel (843)-805-5000

Fax (843)-805-5010

We would like to sincerely thank you for choosing a Beneteau and we wish you good sailing.



II) ANTI-FOULING

The primary function of your Beneteau is to maximize your boating pleasure. Your new Beneteau was made to last through weather and time. From the very beginning, great care has been taken in building your boat. Her molds have been designed and built to resist any deformation of her lines and meticulously maintained to guarantee a superior finish. This is very important because the mold is the cocoon from which your boat emerges.

Between the gel coat layer and the fiberglass laminate, Beneteau applied a nearly impervious Vinylester layer that will virtually eliminate the phenomenon of osmotic blistering in the fiberglass hull. The addition of this product assures that the mechanical properties of your hull remain solid and it's life span greatly improved.

All materials used in the construction of your Beneteau are of the highest quality. Sampling of materials and operational standards are constantly monitored so that the structural design matches the engineered standard.

Beneteau USA takes great care in the manufacturing of fiberglass parts, as well as in the control of raw materials and their applications. This coupled with the mastery of building techniques allows Beneteau USA to offer you the most favorable warranties in the marine industry.

Methodology for anti-fouling application when new:

1. Clean and degrease hull thoroughly using a denatured ethyl alcohol
2. Sand hull using sandpaper with a minimum grit of #220. (i.e., 220, 300, or 400)
3. Rinse with fresh water.

DO NOT USE DETERGENTS. DO NOT PRESSURE WASH.

4. **APPLY ANTI-FOULING TO MANUFACTURER'S DIRECTIONS.**

NOTE: It cannot be emphasized enough that thorough de-waxing must occur. Furthermore, if the gel coat is abraded with coarse sandpaper, it will no longer be impervious to water.

III)

LIMITED WARRANTY

Beneteau USA Inc. ("Beneteau USA") warrants to the original purchaser or any subsequent buyer during the time of this Limited Warranty (the "Owner"), that the boat, excluding parts or accessories not manufactured by Beneteau USA or Chantiers Beneteau, S.A., will be free from defects in material and workmanship for a period of ONE year from the date of the delivery to the original purchaser.

In addition, Beneteau USA warrants to the Owner, except for the prototypes and boats from the California series, that the hull and deck structure of the boat will be free from defects in material and workmanship for a period of FIVE years from the earliest of the following events: delivery of the boat to the original purchaser, first date of utilization, last day of the boat model year.

Beneteau USA's obligation under this warranty shall be limited to the repairing or replacing (or causing to be repaired or replaced), at Beneteau USA's option, the part or parts which are recognized defective by it in material or workmanship within the applicable warranty period to the exclusion of all other remedies. This Warranty shall apply only provided that the Owner presents the boat's Certificate of Origin and gives the selling dealer written notice of any claimed defect within 15 days after such defect is first discovered and satisfactory proof thereof. Warranty repairs do not result in a renewal or extension of the original Warranty for the boat or a part thereof. Transportation charges and duties shall be borne by the Owner.

This Warranty does not extend to: (1) any losses due to misuse, accident, disaster, abuse, neglect, normal wear and tear or improper maintenance; (2) boats or any part thereof which have been repaired or altered without Beneteau USA's prior written approval; (3) accessories or parts not supplied by Beneteau USA or Chantiers Beneteau, S.A., or parts or accessories installed during the process of manufacturing that were not manufactured by Beneteau USA or Chantiers Beneteau, S.A., for which the Warranty will be the one provided by the supplier of the part or accessory; (4) damages resulting from any modification made to the boat; (5) boats for rental, lease, or charter; (6) splits, discoloration, or cracks in the gel-coat (hull, rudder, and deck); (7) disorders in the hull or deck such as, without limitation, blisterings, which are caused by use of improper maintenance products or by improper sanding of the gel-coat; (8) anti fouling, varnishes, paints, acrylon, naughahyde, fabrics, headliners, chrome, anodized coatings, keel coatings, sails, cushions, or running rigging, as these items are subject to deterioration caused by climate, erosion, normal use conditions, or wear and tear; (9) reasonable and necessary maintenance, including, but not limited to, periodic re-bedding of chain plates, stanchion bases, windows and/or window frames, and winches; (10) damages or deterioration due to the non-observance of maintenance recommendations as described in the owner's manual or non-compliance with the normal rules of boat maintenance; (11) failure to take reasonable measures necessary to protect the boat; (12) any damage or deterioration to the boat resulting from participation in a competitive sporting event.

In addition, if (1) any structural damage to the boat is suffered as a result of any cause other than a defect in material or workmanship (whether or not such damage requires or results in any repairs to the hull or deck), or (2) any repairs or alterations to the boat of any nature whatsoever are made at a shipyard not approved in writing by Beneteau USA, then the five-year hull/deck Warranty set forth above will immediately thereupon terminate and be of no further force or effect.

THIS WARRANTY IS EXPRESSLY IN LIEU OF ALL OTHER WARRANTIES EXPRESS OR IMPLIED INCLUDING WITHOUT LIMITATION THE IMPLIED WARRANTIES OF MERCHANTABILITY OR FITNESS FOR A PARTICULAR PURPOSE AND ALL OTHER LIABILITIES ON BENETEAU USA'S PART, AND BENETEAU USA NEITHER ASSUMES, NOR AUTHORIZES ANY PERSON, INCLUDING THE DEALER, TO ASSUME FOR IT, ANY OTHER LIABILITY IN CONNECTION WITH THE SALE OF BENETEAU USA'S BOATS.

Beneteau shall in no event be liable to the Owner or any other person or entity for damages of any kind, including but not limited to direct, indirect, special or consequential damages, arising from the sale or in connection with the use or inability to use the boat for any purpose whatsoever, irrespective of whether the claims or actions for such damages are based upon contract, tort, negligence, strict liability, warranty, or otherwise.

For the purpose of compliance with the Federal Boat Safety Act of 1971 and all notification procedures set forth therein, Beneteau USA requests that you complete the information requested below concerning your current address, which shall be returned to Beneteau USA by your Dealer.

Beneteau USA reserves the right, at any time, to make changes in design or additions to or improvements in the boats without liability or obligation to incorporate such change, addition, or improvement in any boat manufactured prior thereto.

This Warranty gives you specific legal rights. You may also have other rights which vary from state to state.

I hereby acknowledge that Beneteau USA Inc. Limited Warranty was attached to Dealer's purchase order in its entirety at the time that I purchased my boat from said Dealer; that I have read such Limited Warranty in its entirety; and that I have a copy of such Limited Warranty, as attached to Dealer's purchase order, for future reference.

_____	Boat Model _____
Signature	Hull # _____
_____	Dealer _____
Purchaser's Name/Please Print Clearly	_____
_____	Date _____
Mailing Address of Purchaser	_____
_____	_____
City State Zip	_____
_____	_____
(Area Code)	Telephone Number

WARRANTY/REGISTRATION PROCEDURES

Warranty Procedure

All Beneteau boats carry a one year limited warranty, as well as an extended hull and deck structural warranty (see warranty form for details). As the first owner of your new Beneteau, your warranty only becomes valid upon receipt, by Beneteau, of the completed and signed warranty form. It is important that you were presented with this document at the time of your contract with your dealer and that both you and your dealer have signed this form. Your warranty will then take effect upon final delivery to you of your new Beneteau.

Registration Procedure

As a new Beneteau owner you will automatically become a member of Club Beneteau. Club Beneteau will entitle you to many added benefits and advantages as well as providing you with a valuable line of communication with Beneteau. Upon receipt of your completed and signed warranty form we will forward a new owners package directly to you.

Subsequent owners of Beneteaus are invited to become a member of Club Beneteau as well. We will automatically enroll these boat owners upon receipt of their warranty transfer cards.

In the event that you change your address, please fill out and mail in the change of address card at the back of the manual (to the address below) so that you will not miss any of Club Beneteau's opportunities.

If you have any questions concerning this procedure please feel free to contact Beneteau Customer Service at (843)-423-6459.

Warranty Transfer

Your new Beneteau has a transferable, limited hull and deck warranty. In the event of selling your Beneteau, the new owner must be registered with Beneteau within 30 days of the date of sale for the warranty to be transferred.

Please fill in the appropriate warranty registration card at the back of this owner's manual and mail it to:

Beneteau USA Inc.
24 North Market Street
Suite 201
Charleston, SC 29401

IV) HULL IDENTIFICATION NUMBERS

The hull identification or "BEY" number is a unique number given to your Beneteau alone. This number begins with "BEY" which has been assigned to Beneteau by the USCG followed by an alpha-numeric code which details the model, serial no., month of construction, year of construction and model year.

Please clearly identify your boat using your model and "BEY" number during any correspondence with Beneteau.

Your boat identification number appears in two places:

The main hull identification number is located on the aft starboard side, near the transom, stamped into the hull, approximately 3 inches below the toerail.

The second hull identification number is in a hidden area for anti-theft purposes.

V) DEALER'S RESPONSIBILITIES

Your Beneteau Dealer is part of a worldwide distribution network, with dealers in 28 countries. As a Beneteau Dealer, he has certain obligations to you as our customer and to Beneteau as our representative. A Dealer's responsibility does not end with the sale of your boat. Your Dealer is responsible for the following:

- Deliver your new Beneteau to you complete as ordered in your purchase agreement.
- Preparation of your boat for commissioning by their personnel, another yard or by providing you with the correct commissioning procedures.
- Checking of all systems on the boat for fit, proper function and to familiarize you with the usage of each system.
- Sea trial of your new Beneteau with you as a final verification that all systems are in good order.
- Providing customer support and parts after you take delivery and any warranty service under the terms of the limited warranty. All warranty questions/claims or processing should be directed through your dealer.

VI) OWNER'S/OPERATOR'S RESPONSIBILITIES

STATE REGISTRATION OR FEDERAL DOCUMENTATION

For State Registration please consult you're Dealer or the State Marine Police, who can provide the correct governmental department handling registration in your state.

SAFETY AND MAINTENANCE

For maximum enjoyment of your Beneteau, due respect should be given to proper safety and maintenance procedures.

Be sure that your boat is operated according to the U.S. Coast Guard Regulations as outlined in the "Federal Requirements for Recreational Boats". Please familiarize yourself with all operating requirements.

Prepare yourself for any situation before going out on the water. Follow the instructions provided in the sections of this owner's manual, the individual supplier instruction manuals, and all applicable U.S. Coast Guard and other regulations. If you are not an experienced sailor, you should complete an accredited sailing course.

Before leaving the dock, be sure that all your equipment is in working order, that you are aware of the weather conditions, and someone ashore is familiar with your destination or sailing activities.

MANDATORY COAST GUARD SAFETY EQUIPMENT

Many safety items are required for compliance with the U.S. Coast Guard regulations. Note that these regulations are subject to change. It is the owner's responsibility to be aware of current regulations as outlined in the "Federal Requirements for Recreational Boats". For your convenience a copy is included with your yacht's documentation, and additional copies may be obtained by calling the U.S. Coast Guard Boating Safety Hotline at (800) 368-5647.

Good safety equipment should be a priority of every sailor for the protection and comfort of passengers. Passengers aboard should be made familiar with the safety equipment and operation of the boat in the event of an emergency.

Depending on the length, passenger capacity, and operating conditions, your boat must be equipped according to the current USCG requirements. Be sure that you operate your boat with the necessary number of life preservers, fire extinguishers, signaling devices, distress signals, navigation lights as referred to in the "Federal Requirements for Recreational Boats."

RECOMMENDED SAFETY EQUIPMENT

Preparation is the key to safety on the water.

Your new Beneteau has been fitted with the following equipment:

- Compass - be sure that it is properly calibrated to give the correct magnetic reading.
- A large capacity bilge pump.

We recommend that you fully outfit your Beneteau with safety equipment that can be obtained through your dealer or marine supply outlets. These items should include but not be limited to:

- Up to date nautical charts covering your intended cruising area.
- Boat hook.
- Large waterproof flashlight with spare batteries.
- Fenders.
- Docking lines - a good rule of thumb to follow dictates that your bow, stern, and spring line be equal to the length of the boat.
- Life jackets, anchor, anchor chain and line, throwing line, flares, soft wooden plugs for thru-hulls, life ring, fire extinguisher, and foghorn.
- Electronics - Depth Sounder, Log Speedometer, and VHF Radio.

SAFETY COURSES

It is recommended that owners and operators gain knowledge and experience in boat safety skills such as:

- (a) Navigation
- (b) Seamanship and boat handling
- (c) Rules of the road, international and inland waterway
- (d) Weather prediction
- (e) Safety at sea
- (f) Survival in bad weather
- (g) Respect for others on the water
- (h) First aid
- (i) Radio communication
- (j) Distress signals
- (k) Pollution controls

To find out where one can attend these courses in your area, please call your dealer or "The Boaters Educational Course Line" at (800) 336-2628.

ANCHORING

Various sea and bottom conditions require different anchoring systems. Your dealer can help in choosing rode size and length, anchor chains, and working and storm anchors most appropriate for your boat and location.

In general, a minimum of two anchors should be carried at all times and enough anchor rode and chain necessary for the depth of water to be navigated during storm conditions.

Certain anchors are useful for a variety of bottom conditions. Study the charts of the area to be navigated for information concerning bottom conditions and water depth.

The greatest hazard with a sound permanent mooring is the chafe, which can occur to the rode at the bow chocks. This is the single most common site of failure. Care is advised in the selection and protection of the rode pennant with appropriate chafing gear. Careful and regular inspection of moored boats on a regular basis is necessary to ensure the boat's safety.

ADDITIONAL SAFETY EQUIPMENT

A number of additional safety items are worthy of your consideration. These range from safety harnesses to emergency beacons, life rafts, and survival suits. Their use depends upon the intended use of the yacht. We suggest you investigate the necessity of these items through discussion with your dealer or local chandler.

MEDICAL KIT

Every yacht should carry a first aid manual, and a medical kit tailored to the specific needs of the owner. Any ship's store should carry a standard type medical kit. Items in the kit should include but not be limited to the following:

- Aspirin
- Adhesive strips and tape
- Antiseptic wipes
- Gauze bandages
- Sunscreen first aid/burn cream
- Sterile pads
- Ace bandages & splints
- Motion sickness pills
- Ammonia inhalants
- Antiseptic germicide ointment
- Zinc oxide ointment
- Insect/bee sting relief ointment/spray
- Cold packs for sprains
- Scissors & tweezers

TOOL KIT

A basic kit should consist of:

- Wrenches - adjustable, Metric and SAE open end, box, socket
- Hammers - large and small
- Knife - with marlinespike
- Screwdrivers - large and small, standard and Phillips
- Pliers - regular, cutting and needle nose, vise grips
- Wire cutter - capable of cutting standing rigging
- Hacksaw - with spare blades

SPARE PARTS

A basic kit should consist of the following:

- Standing and Running Rigging: Turnbuckles, monel seizing wire, clevis and cotter pins, shackles, blocks, extra line, rigging tape, duct tape.
- Fasteners: Assortment of stainless steel screws, nuts, bolts, and washers
- Hose clamps.
- Electrical: Electrical tape, wire, crimps on lugs, spare navigation light bulbs.
- Lubricating supplies: WD-40 and silicone grease.
- Engine: Check engine manual for spare parts, engine oil and transmission fluid recommendations.
- Sails: Sail repair kit and sail slides.

VII) SAFE OPERATION AND WARNING LABELS

Ensure that the boat operator is not under the influence of drugs and/or alcohol.

Do not venture out in weather or sea conditions beyond the skill or experience of the operator.

There are "Warning" and "Caution" statements affixed to your Beneteau. These are detailed below with location:

FUEL WARNING LABEL

- Affixed to the fuel tank.

Beneteau Part #00001027

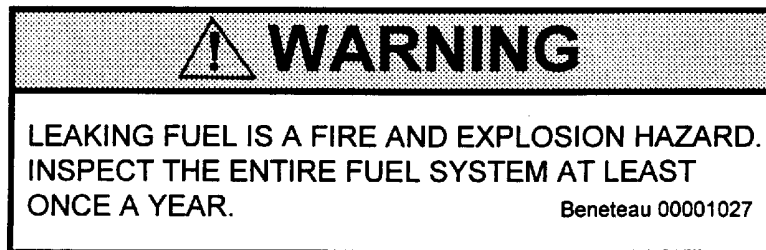

SHORE-POWER LABEL

- At the 110V distribution panel.

Beneteau Part #00001028

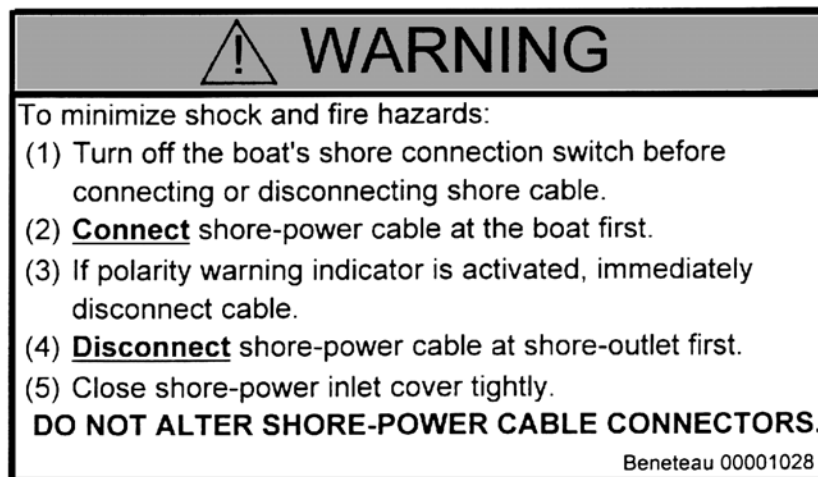

PROPANE LABELS

- At the propane stove affixed to the bulkhead in the galley

Beneteau Part #00001021

 CAUTION
<p>(1) THIS APPLIANCE IS DESIGNED FOR USE WITH LIQUEFIED PETROLEUM GAS (LPG) ONLY. DO NOT CONNECT COMPRESSED NATURAL GAS (CNG) TO THIS SYSTEM.</p> <p>(2) Keep cylinder valve(s) and solenoid valve(s) closed when boat is unattended. Close them immediately in any emergency. When on board, cylinder valve(s) or solenoid valve(s) shall be closed when appliances are not in use. Keep empty cylinder valves tightly closed.</p> <p>(3) Close appliance valve(s) before opening cylinder valve(s).</p> <p>(4) Test LPG system as recommended in sign posted in vicinity of LPG cylinder.</p> <p>(5) Apply ignition source to burner before opening appliance valve.</p> <p>NEVER USE FLAME TO TEST FOR LEAKS.</p> <p style="text-align: right;">Beneteau 00001021</p>

Beneteau Part #00001026

 WARNING
<p>OPEN FLAME COOKING APPLIANCES CONSUME OXYGEN THIS CAN CAUSE ASPHYXIATION OR DEATH MAINTAIN OPEN VENTILATION DO NOT USE THIS APPLIANCE FOR COMFORT HEATING</p> <p style="text-align: right;">Beneteau 00001026</p>

- In the propane locker affixed under the propane locker lid

Beneteau Part #00001024

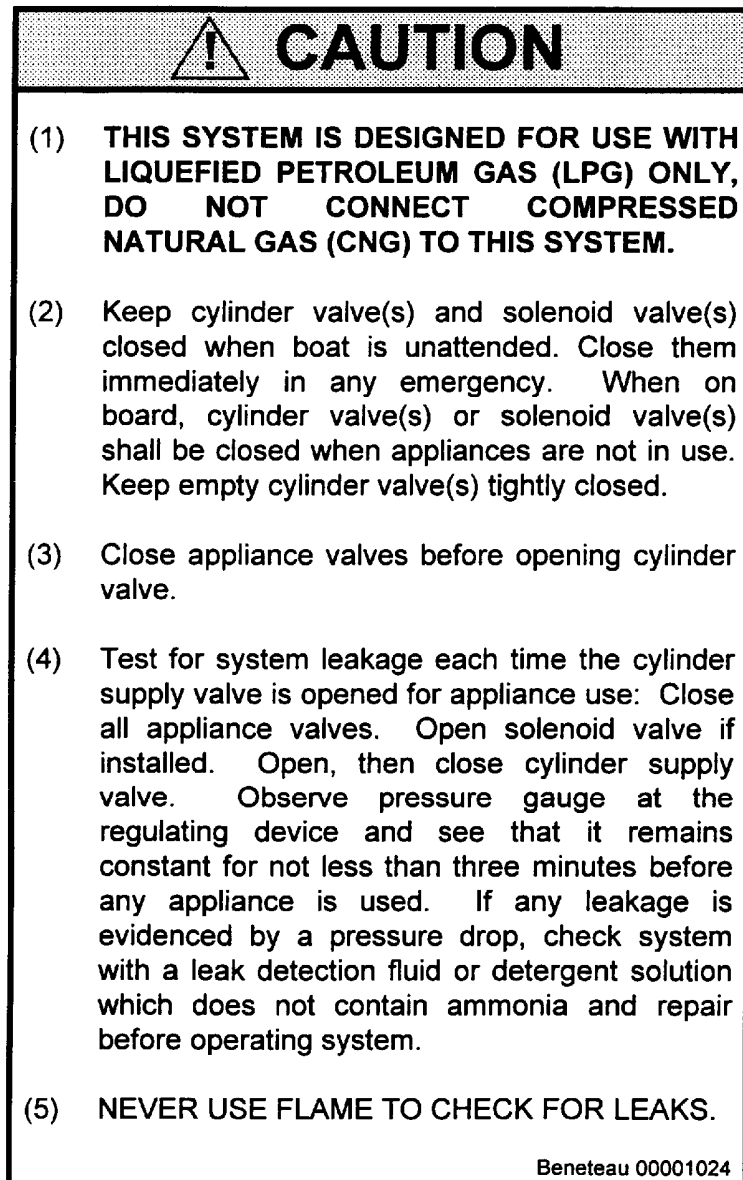

- On or next to the LP Gas Line

Beneteau Part #00001030

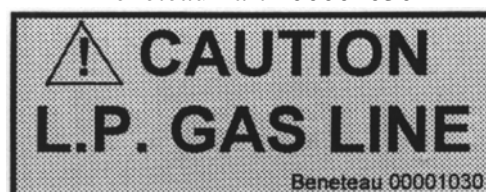

SWIM LADDER WARNING LABEL

- Located on the transom

Beneteau Part # 00001022

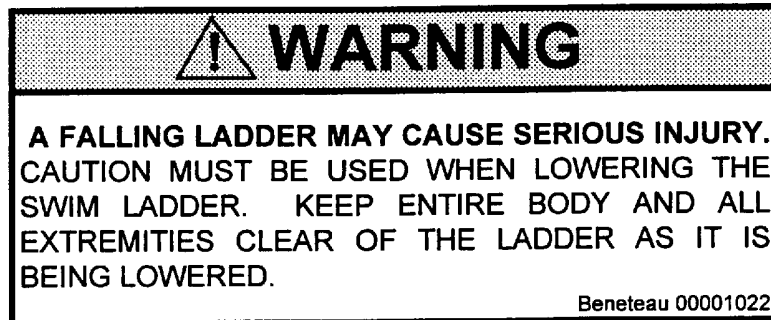

HIGH VOLTAGE WARNING LABEL

- Located beside the 110v electric panel.

Beneteau Part #00001034

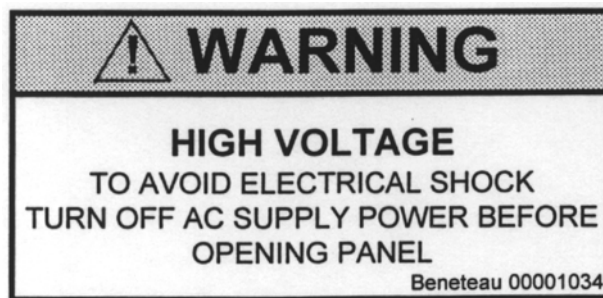

TRANSOM DOOR WARNING LABEL

- Located on or next to the helmsman's seat. (Not applicable on all models)

Beneteau Part #00001031



STANDARD BATTERY SWITCH LABEL

- Located at the standard battery switches.
Beneteau Part #00001032

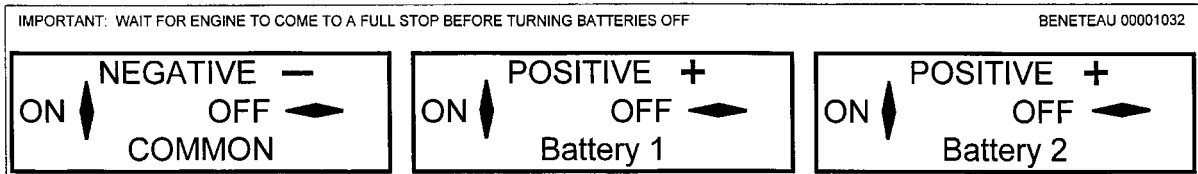

OPTIONAL BATTERY SWITCH LABEL

- Located at the optional battery switches
Beneteau Part #00001023

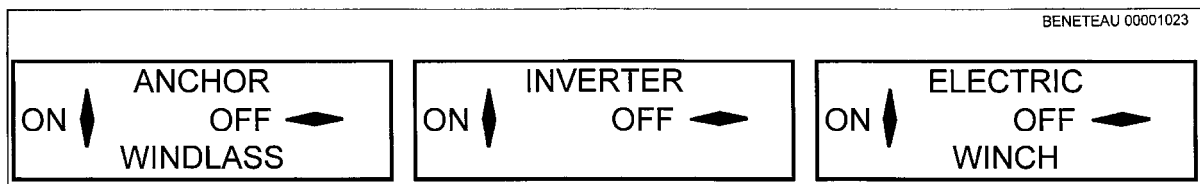

SLING LOCATION ARROWS LABEL

- Located at or near the hull to deck joint
Beneteau Part #00001033

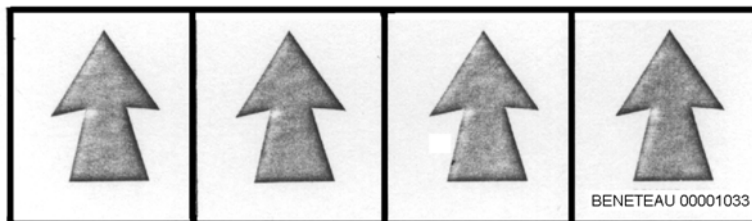

ANTI FREEZE CAUTION TAG

- Tied to the breaker for the water
Beneteau Part #00001038

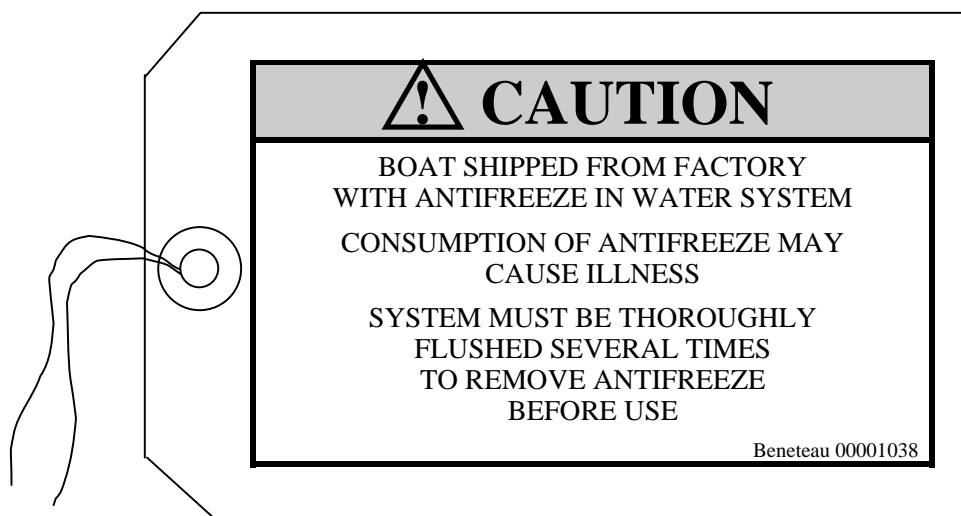

VIII) FEDERAL/STATE REGULATIONS

DISCHARGE OF OIL

- Located: under the sail locker lid.

Beneteau Part #00001007

DISCHARGE OF OIL PROHIBITED

The Federal Water Pollution Control Act prohibits the discharge of oil or oily waste into or upon the navigable waters of the United States or waters of the contiguous zone if such discharge causes a film or sheen upon, or discoloration of, the surface of the water, or causes a sludge or emulsion beneath the surface of the water. Violators are subject to a penalty of \$5,000.



BENETEAU

0000 1007

SOLID WASTE DISPOSAL

- Located under the sail locker lid.

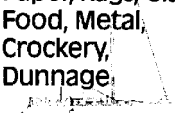
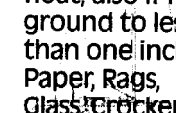
Beneteau Part #00001025

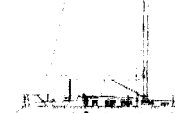
<p>It is illegal for any vessel to dump plastic trash anywhere in the ocean or navigable waters of the United States. Annex V of the MARPOL TREATY is an International</p>		<p>Law for a cleaner, safer marine environment. Violation of these requirements may result in civil penalty up to \$25,000, fine and imprisonment.</p>	
<p>3 Miles from Shore</p>	<p>3-12 Miles from Shore</p>	<p>12-25 Miles from Shore</p>	<p>Outside 25 Miles</p>
<p>U.S. Lakes, Rivers, Bays and Sounds ILLEGAL TO DUMP Plastic & Garbage, Paper, Rags, Glass, Food, Metal, Crockery, Dunnage.</p> 	<p>ILLEGAL TO DUMP Plastic, Dunnage, lining & packing materials that float, also if not ground to less than one inch; Paper, Rags, Glass, Crockery, Metal, Food</p> 	<p>ILLEGAL TO DUMP Plastic, Dunnage, lining & packing materials that float</p> 	<p>ILLEGAL TO DUMP Plastic</p> 
<p>State and local regulations may further restrict the disposal of garbage.</p>			<p>BENETEAU 00001025</p>

MARINE SANITATION

Your Beneteau is equipped with an USCG approved marine head and holding tank.

By law you must use a holding tank in all U.S. waters, Check with local authorities for regional laws governing your area before selecting the overboard discharge option.

ACCIDENT REPORTING

Knowledge of accident reporting requirements. Please refer to the following list for a copy of the U.S. Coast Guard Boating Accident form. For further information on where to obtain more forms, please call the U.S. Coast Guard Boating Safety Hotline at (800) 368-5647

NATIONAL VESSEL DOCUMENTATION CENTER
2039 STONEWALL JACKSON DR.
FALLING WATERS, WV 25419
TOLL FREE: 1-800-799-8362
PHONE: (304) 271-2400
FAX: (304) 271-2405

RENDERING ASSISTANCE

United States Code, Title 46:

"The owner or operator of a vessel is required by law to render assistance to any individual or vessel in distress, so long as his vessel is not endangered in the process."

IX) COMMISSIONING

COMMISSIONING PROCEDURES

The first commissioning of a yacht is essentially the start of its life, and the importance of proper commissioning procedures at this time cannot be overstated. The first commissioning procedure must be performed by Beneteau dealer personnel or those authorized by them. The dealer will also have a commissioning checklist to be signed by the owner and a dealer representative at the time of the first commissioning. The owner also needs to concern himself with items such as safety equipment, which is considered to be his responsibility. See the Owner's Operator's Responsibilities section for details.

Lists of the pre-launch and post-launch checks employed during commissioning are provided in this section for those owners interested in understanding the decommissioning procedure, as well as for future use in any recommissionings that may be required after periods of wet or dry storage. The lists are of a general nature and do not attempt to provide step-by-step instructions.

The following is a list of minimum commissioning duties. Additional operations may be required dependent upon the model & equipment

PRIOR TO LAUNCH

- _____ All accessories & options supplied per shipping list and boat order
- _____ Check hull and repair any shipping damage - aft end of keel, rudder, etc.
- _____ Prep bottom and apply bottom paint if needed.
- _____ Thru hulls inspected and closed.
- _____ Clean hull thoroughly.
- _____ Check clamps on all thru hulls below waterline.
- _____ Wax hull topsides.
- _____ Dock lines and fenders should be supplied by owner and aboard.
- _____ Check tightness of nuts on prop shaft and zinc. (Folding props require additional steps).
- _____ Check steering system (rudder moving freely stop to stop and does not touch hull?). (Hydraulic steering requires all fittings be checked and the system is bled)
- _____ Zincs installed.
- _____ Thru hulls unobstructed and speed/log impeller in place (if applicable).
- _____ Fuel valve turned ON.
- _____ Check keel bolts for tightness.

OPERATIONS AFTER LAUNCH

- _____ No water leaks, stuffing box, shaft log, strut, rudder post.
- _____ No leaks at thru hulls; all hose clamps secure with seacocks open.
- _____ Fill water tanks, no leaks at fill pipes, overflows or connections.
- _____ Fill fuel tank.
- _____ Batteries secured, connected, filled and charged.
- _____ Check all cabin lights.
- _____ Check all navigation lights.
- _____ Water pressure system - air bled, no leaks at connections.
- _____ Check electric sump pumps and bilge pump.
- _____ Check manual bilge pump
- _____ Check emergency tiller fit.
- _____ 110V shore power polarity ok and breakers on
- _____ Battery charger ok.
- _____ Hot water heater works-must be filled before turning on.
- _____ Check head operation and holding tank for leaks.
- _____ Test wash down pumps, refrigeration, heaters, etc.
- _____ Test stove and LPG tank for leaks and proper operation
- _____ **DO NOT TEST FOR LEAKS WITH AN OPEN FLAME, WIPE EACH JOINT WITH A SOAPY SOLUTION AND LOOK FOR BUBBLES**

ENGINE START-UP

- _____ Check transmission for proper fluid and proper level.
- _____ Check crankcase dipstick for proper fluid and proper level.
- _____ Check shift and throttle cables for proper adjustment and secure end fittings.
- _____ Engine alarms work when key is on.
- _____ Open engine water intake.
- _____ Start engine, check gauges and water flow at exhaust is normal.
- _____ Check water level in heat exchanger and expansion tank.
- _____ Check belts and mounts.
- _____ Run engine at operating temperature. Note temperature _____ degrees.
- _____ No engine or fuel line leaks-no chafe problems with wires.
- _____ Forward and reverse gears operate.
- _____ After warm-up, shut engine down, check oil, and fluid levels again.
- _____ Alignment to under .003 - coupling bolts tightened.
- _____ Idle set correctly , engine won't stall when put in gear.
- _____ Allow engine to run for at least (1) hour.
- _____ No leaks at the shaft seal.
- _____ Shift and throttle operate smoothly with engine running.
- _____ No leaks at keel bolts after engine run.

PRIOR TO STEPPING MAST

- _____ Clean or wax spar.
- _____ Mast sheaves free running.
- _____ Run halyards if necessary– Make sure you have clean hands on clean ground.
- _____ Attach and secure all stays and shrouds.
- _____ Attach and secure spreaders to mast and upper shrouds.
- _____ Check boom gooseneck fitting.
- _____ Install mast boot on spar if applicable.
- _____ Check all mast lights.
- _____ Attach and secure boom topping lift.
- _____ Check running lights and electrical connections.
- _____ Protect against chafe on spreader ends and any fitting.
- _____ Check sail track for burrs.
- _____ Turnbuckles attached.
- _____ Re-check all pins, cotters, and Locktite any shackles.
- _____ Check with salesman and work order for additional mast gear.
- _____ Furling system built and connected to mast

AFTER STEPPING MAST

- _____ Protect spar from scratching on mast collar on keel stepped masts.
- _____ Turnbuckles lubricated.
- _____ Attach standing rigging to chain plates.
- _____ Chock mast partner and seal mast boot on keel stepped masts.
- _____ All mast wiring connected.
- _____ Preliminary tune - spar straight - shrouds proper tension.
- _____ Run reefing lines and halyards.
- _____ All cotter pins in place on turnbuckles and opened.
- _____ Run main sheets and attach topping lift.
- _____ Tape chain plates and cotter pins to prevent chafe.
- _____ Check and double-check all turnbuckles, cotter and clevis pins.

PRIOR TO DELIVERY

- _____ Hose test all ports, deck hardware, chain plates, and stanchion posts for leaks.
- _____ Tighten lifelines and tape split rings.
- _____ All doors, drawers, floorboards, hatches, and cabinets operate freely - fit if necessary.
- _____ Clean thoroughly: sinks, bulkheads and counter tops, all lockers and drawers, bilge, cushions, deck and cockpit lockers.
- _____ Dry the bilge completely.
- _____ Clean and oil exterior teak if needed.
- _____ Clean cabin sole, deck area and ports.
- _____ All Coast Guard and safety gear aboard.
- _____ Sails bent on, ALL HEADSAILS FIT FURLING.
- _____ All electronics and optional gear tested and working.

X) SPECIFICATIONS OF THE BOAT

Type..... BENETEAU 393
 Name of Builder BENETEAU USA INC.
 Design Category A
 No. of acknowledged body CE 0607

Hull Length		11.62 m	38.12 ft
Hull Beam		3.96 m	12.99 ft
Draft:	Shoal	1.55 m	5.08 ft
	Deep	1.90m	6.23 ft
Clearance Height		15.65 m	51.35 ft

FOR U.S. COAST GUARD DOCUMENTATION

The “*depth*” from the top of hull to the bottom of hull at the midship line is 1.8m (5.9 ft)

Maximum Authorized Engine Power :	50 kW	67 hp
-----------------------------------	-------	-------

Fuel Capacity	135 L (35 US gal)
Fresh Water Capacity	500 L (132 US gal)
Battery Capacity	100A engine 200A house

DESIGN CATEGORIES

- Category A: OCEAN – Designed for extended voyages where conditions may exceed wind force 8 (Beaufort scale) and significant wave heights of 4 m and above, and vessels largely self sufficient
- Category B: OFFSHORE – Designed for offshore voyages where conditions up to, and including, wind force 8 and significant wave heights up to, and including, 4 m may be experienced.
- Category C: INSHORE – Designed for voyages in coastal waters, large bays, estuaries, lakes and rivers where conditions up to, and including, wind force 6 and significant wave heights up to, and including, 2 m may be experienced.
- Category D: SHELTERED WATERS – Designed for voyages on small lakes, rivers, and canals where conditions up to, and including, wind force 4 and significant wave heights up to, and including, 0.5 m may be experienced.

Category	Height of the Waves (ft)	Wind Force (Beaufort)
A	> 4 m (13.0 ft)	> 8
B	< 4 m (13.0 ft)	≤ 8
C	< 2 m (6.5 ft)	≤ 6
D	< .5 m (1.6 ft)	≤ 4

For additional information concerning the standard equipment, please refer to the manuals enclosed with the boat.

Maximum recommended number of persons on board by design category:

Category	Maximum Number of Persons
A	8
B	10
C	12
D	12

The C.E. Certified equipment includes: The fuel tanks, parts of the steering system, parts of the gas system and the hatches and portholes.

WEIGHT ESTIMATION

SAILING CATEGORIES	A	B	C	D
	Kg (lbs)	Kg (lbs)	Kg (lbs)	Kg (lbs)
Light Boat :	7650 (16,866)	7650 (16,866)	7650 (16,866)	7650 (16,866)
Safety Equipment :	100 (220)	100 (220)	100 (220)	100 (220)
Sail :	30 (66)	30 (66)	30 (66)	30 (66)
Light Displacement :	7780 (17,152)	7780 (17,152)	7780 (17,152)	7780 (17,152)
Life Raft :	80 (176)	80 (176)	80 (176)	80 (176)
Crew :	600 (1,323)	750 (1,653)	900 (1,944)	900 (1,944)
Water :	480 (1,058)	480 (1,058)	480 (1,058)	480 (1,058)
Fuel :	112 (247)	112 (247)	112 (247)	112 (247)
Personal Equipment :	210 (463)	210 (463)	210 (463)	210 (463)
Optional Equipment				
Holding Tank :	90 (199)	90 (199)	90 (199)	90 (199)
Air Conditioning :	80 (176)	80 (176)	80 (176)	80 (176)
Teak Deck	140 (309)	140 (309)	140 (309)	140 (309)
Auto Pilot Gear :	20 (44)	20 (44)	20 (44)	20 (44)
Mech. Refrigeration	20 (44)	20 (44)	20 (44)	20 (44)
Spinnaker Rigging :	10 (22)	10 (22)	10 (22)	10 (22)
Microwave Oven :	5 (11)	5 (11)	5 (11)	5 (11)
Roof Sprayhood :	20 (44)	20 (44)	20 (44)	20 (44)
Bimini Top :	20 (44)	20 (44)	20 (44)	20 (44)
Davits :	40 (88)	40 (88)	40 (88)	40 (88)
SUB TOTAL (Optional Equipment)	445 (981)	445 (981)	445 (981)	445 (981)
Margin for Other Equipment	450 (992)	300 (662)	150 (331)	150 (331)

MAXIMUM LOAD DISPLACEMENT Kg (Lbs.)	10157 (22,392)	10157 (22,392)	10157 (22,392)	10157 (22,392)
--	-----------------------	-----------------------	-----------------------	-----------------------

MAXIMUM LOAD Kg (Lbs.)	2377 (5,240)	2377 (5,240)	2377 (5,240)	2377 (5,240)
-----------------------------------	---------------------	---------------------	---------------------	---------------------

MAXIMUM LOAD = MAXIMUM LOAD DISPLACEMENT – LIGHT BOAT

ANY OVERLOADING CARRIES A RISK OF FLOODING OR LOSS OF STABILITY

XI) INTERIOR LAYOUT

2 Cabin 2 Toilet Version

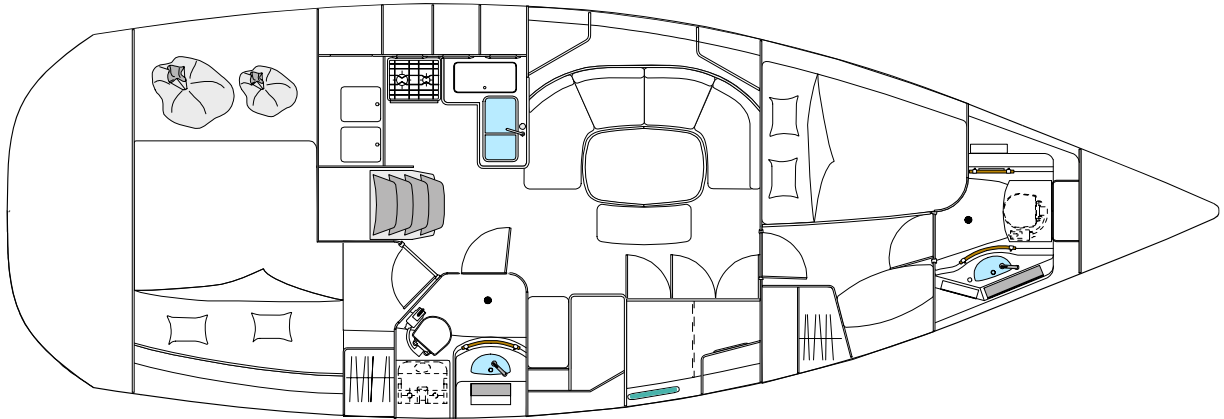

3 Cabin 2 Toilet Version

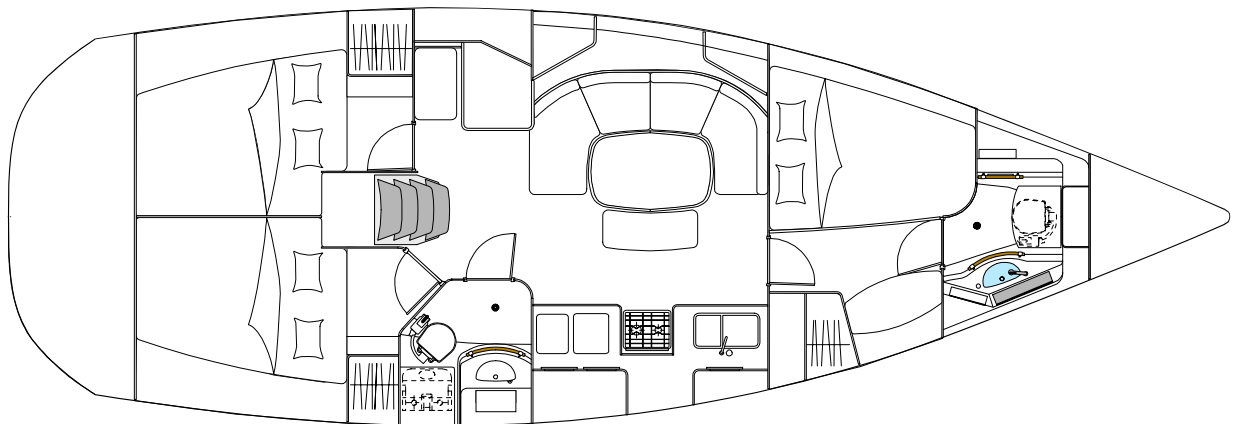

EXIT IN CASE OF FIRE



= EMERGENCY EXIT



= RECOMMENDED FIRE EXTINGUISHER LOCATION

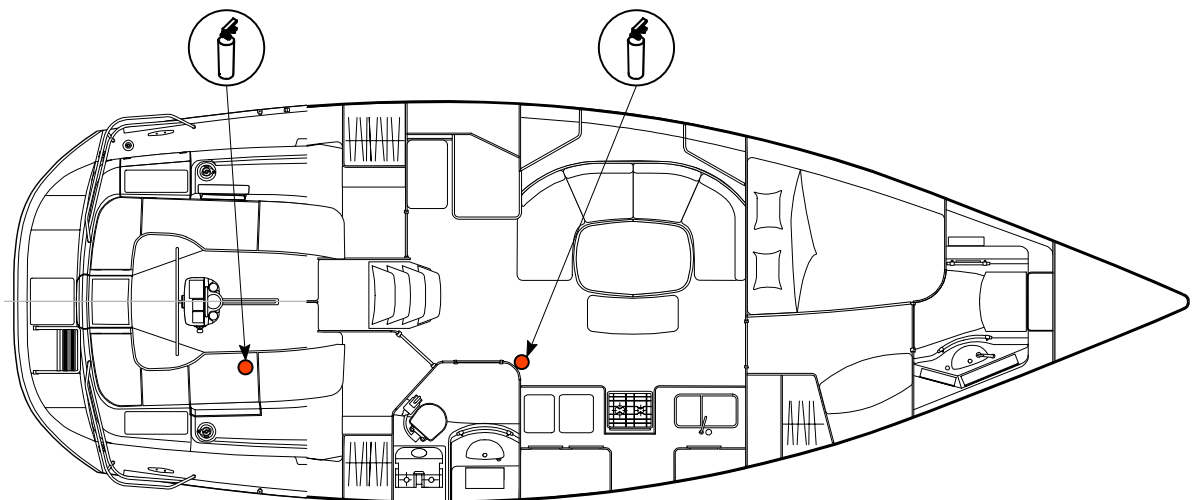
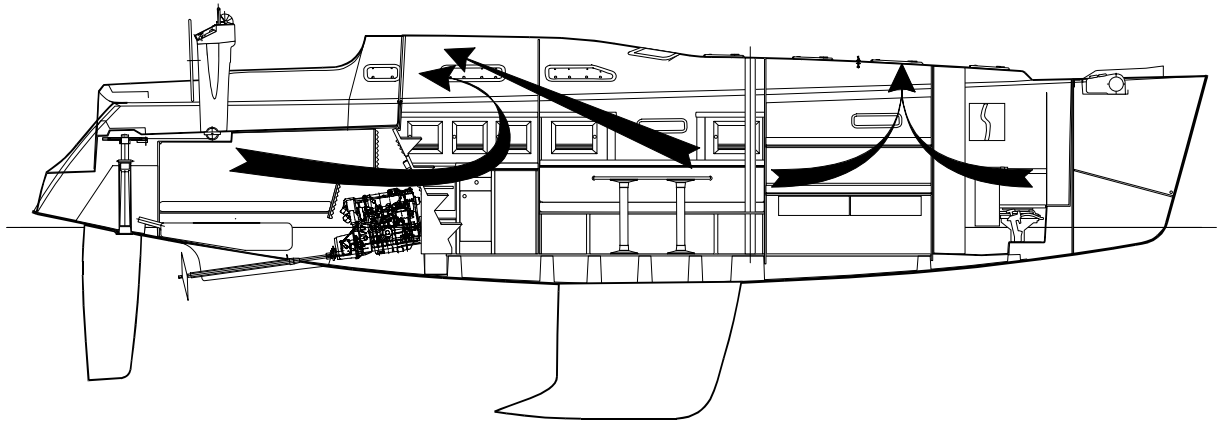

XII) DECK

- Jack lines can be fastened either to the mooring cleats, or to pad eyes on deck.

The Beneteau 393 is fitted with a foldaway swimming ladder. The swimming ladder should be in its folded/upright position as soon as you are on board.

Make sure that the hatches and portholes are closed before you put out to sea.

In case of rough sea, close the boat with the sliding hatch and weatherboards so that no water may come into the boat.

Check that nothing blocks up the cockpit drain holes; these holes should never be sealed.

- 1 Recommended location of the life-raft
- 2 Fwd water tank deck fill
- 3 Fwd waste tank pump out deck plate
- 4 Aft water tank deck fill
- 5 Aft waste tank pump out deck plate
- 6 Fuel deck fill
- 7 Swim ladder

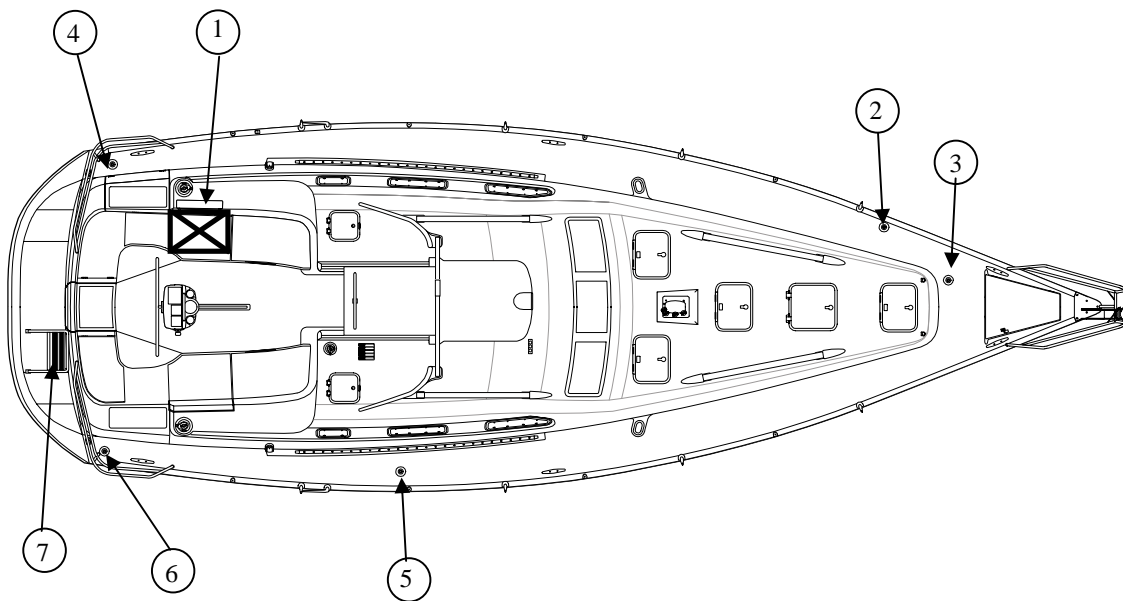

XIII) SAILS AND RIGGING

Specifications of the Sails:

SAIL	AREA	
	Roller furling main	Classic main
Total	98.00 m ²	105.17 m ²
Mainsail	35.15 m ²	42.32 m ²
Genoa (140%)	62.85 m ²	62.85 m ²

Roller furling mast			Classic mast		
I	16.42	m	I	16.42	m
J	5.55	m	J	5.55	m
P	14.44	m	P	14.54	m
E	5.20	m	E	5.20	m

Specifications of the Standing Rigging:

V: VERTICAL - D: DIAGONAL

REF	CABLE	Dia. In.
1	V1 (Shroud)	3/8
2	D1 AFT (Aft Lower Shroud)	5/16
3	V2D3 (Upper Shroud)	5/16
4	D2 (Inter)	9/32
5	Forestay	5/16
6	Baby Stay	9/32
7	Backstay	9/32

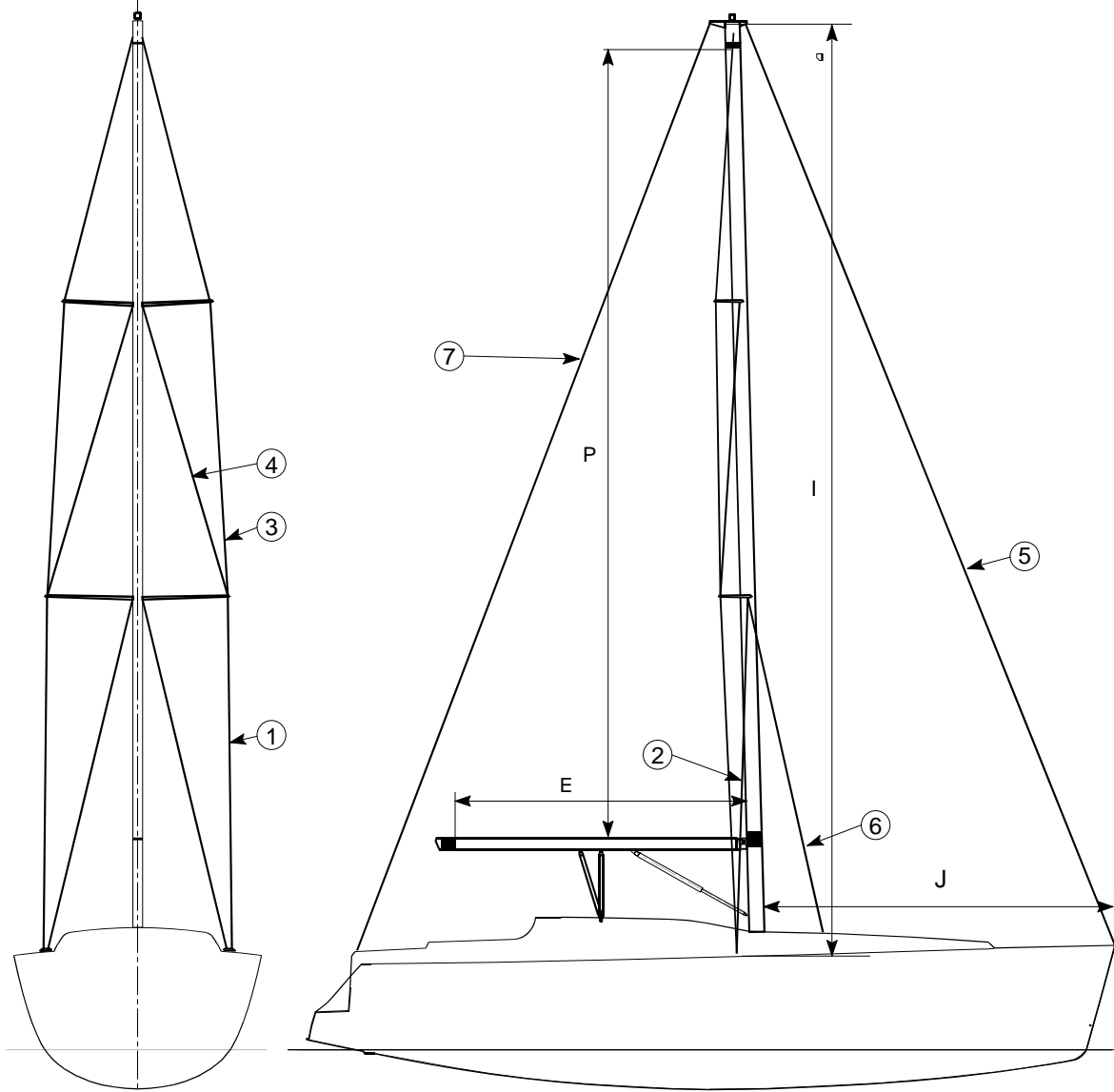

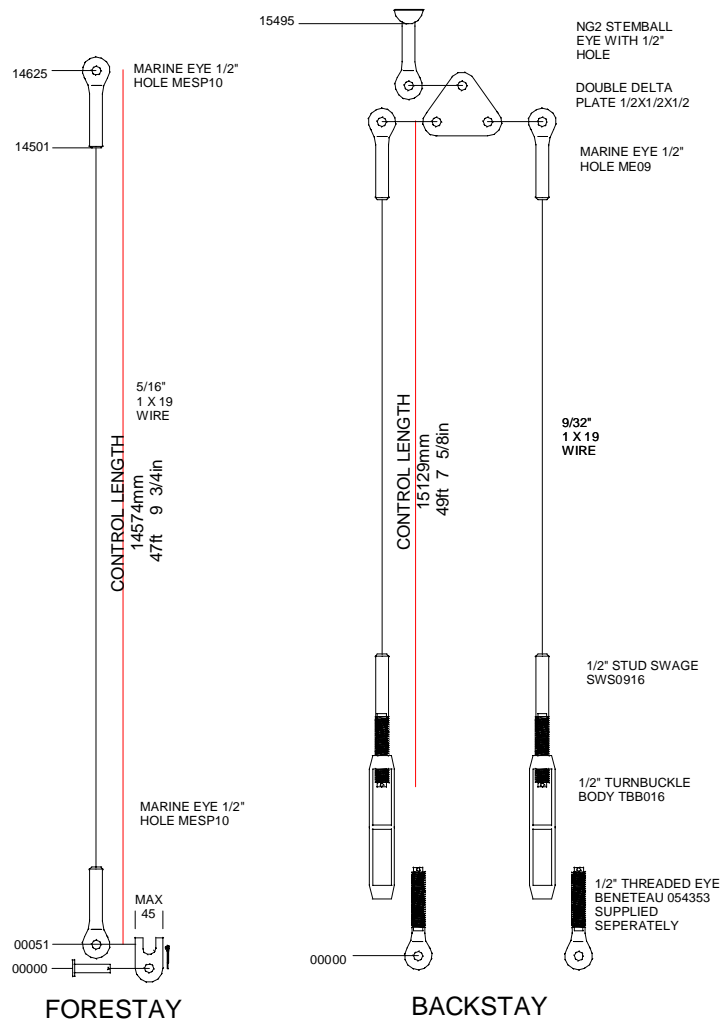

Material:		Designation:		Visa:	
		SCALE:	TOL.GEN.:	Designed: 06/11/01	
		STANDING RIGGING KIT O393 BOX1 (1 BOX)		By: BADB	
		Beneteau USA INC. 1313 HIGHWAY 76 WEST PO DRAWER 1218 MARION, SC 29571		Approved:	
		Tel. (843) 423-4201 - Fax. (843) 423-4912		By:	
				Weight:	Lb
Ind.	Modification	Par	Dates	N°:08020178	
Ce document est notre propriété, il ne pourra être reproduit ou communiqué sans notre autorisation.					

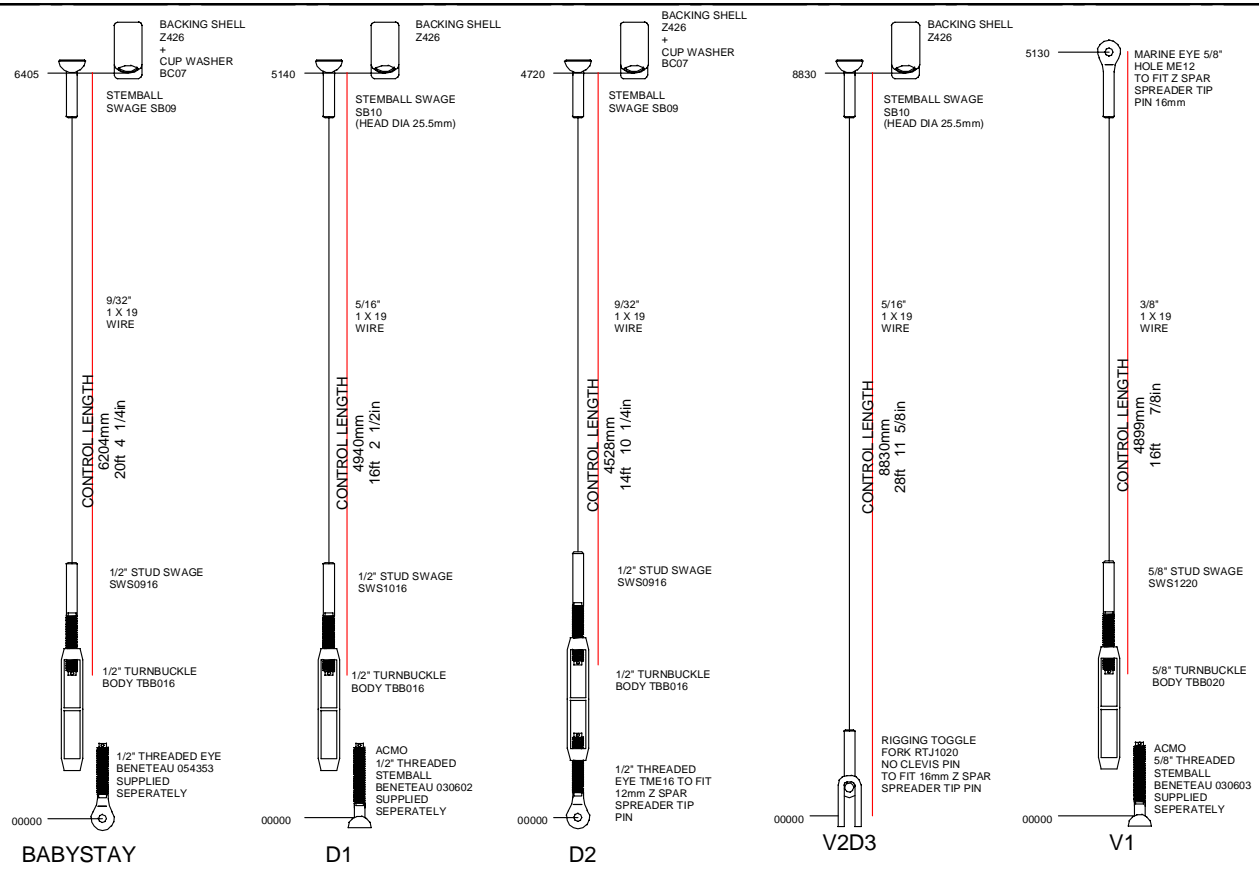

Material:		Designation:		Visa:
		SCALE:	TOL.GEN.:	
		STANDING RIGGING KIT O393 BOX 2 (2 BOXES)		
		Beneteau USA INC. 1313 HIGHWAY 76 WEST PO DRAWER 1218 MARION, SC 29571 Tel. (843) 423-4201 - Fax. (843) 423-4912		Designed: 06/11/01 By: BADB
				Approved: By:
				Weight: Lb
Ind. Modification		Par Dates		Nº:08020179
Ce document est notre propriété, il ne pourra être reproduit ou communiqué sans notre autorisation.				

MAKE	PROFURL
MODEL	B35S
NUMBER OF EXTRUSIONS	6 X 2M & 1 X 1814
FORESTAY DIAMETER	5/16" 1X19 SS CABLE

PLASTIC MULTI TOP HALYARD RESTAINER CAP

PLAY 15mm

HALYARD SWIVEL WITH HALYARD SHACKLE
8mm BOW

INTEGRAL FEEDER

NO PRE-FEEDER

ADJUSTABLE TACK SHACKLE ON TURNBUCKLE CYLINDER
8mm BOW SHACKLE

24.38M x 8mm DACRON LINE :
(80' x 5/16")

STAINLESS STEEL DRUM GUARD

PLASTIC SPLIT DRUM

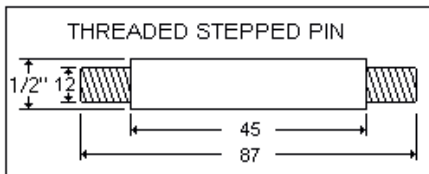

ABOVE THREADED STEPPED PIN ATTACHES SWAGED EYE TO THE DOUBLE JAW TOGGLE AND PROFURL LINK PLATES
DOUBLE JAW TOGGLE SUPPLIED WITH FORESTAY

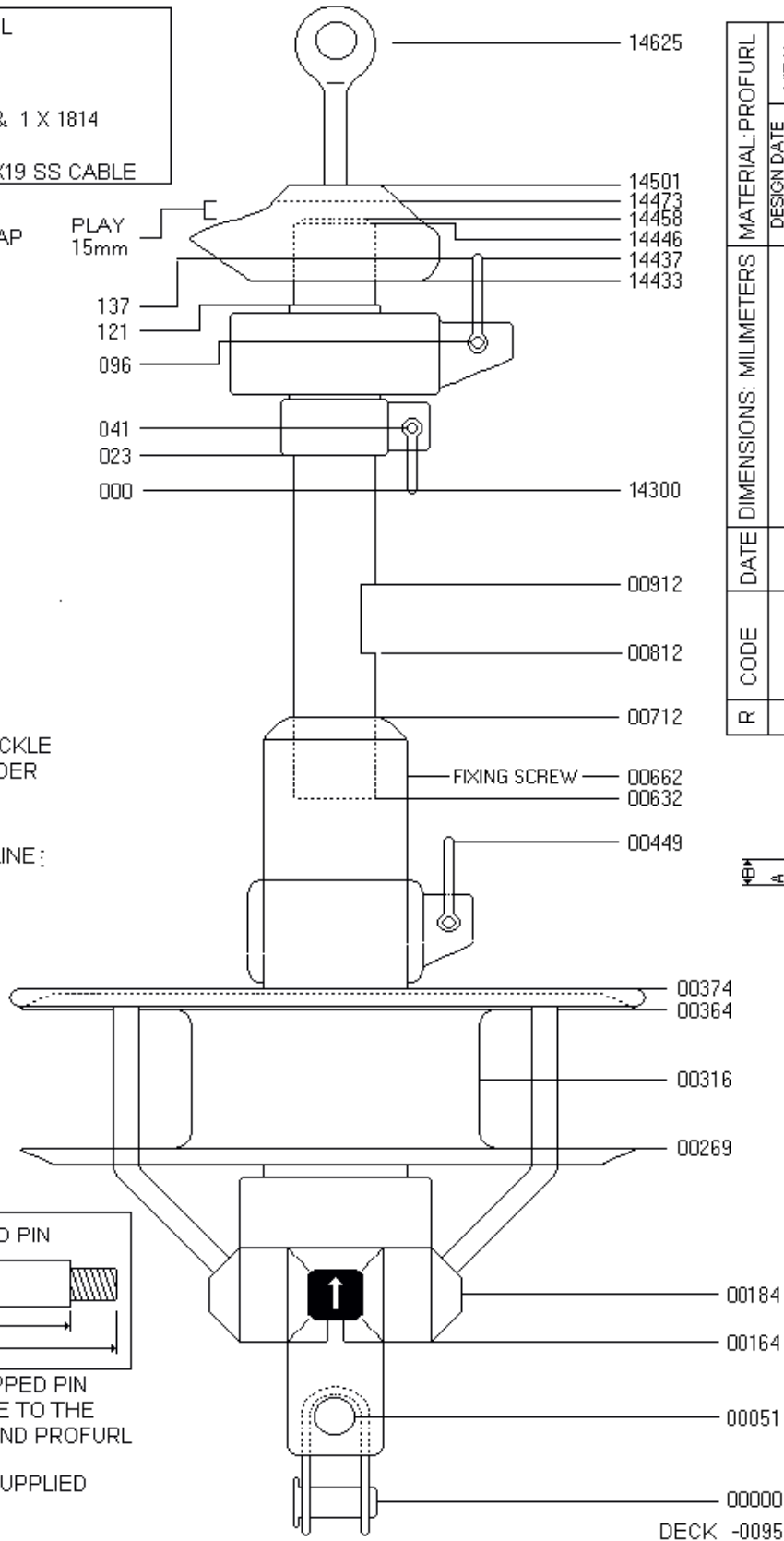

R	CODE	0	PROTOTYPE	DATE	3-8-01	DIMENSIONS: MILLIMETERS	SCALE: NONE	GEN. TOL. NONE	MATERIAL: PROFURL
	DATE	3-8-01	VIEW	DESIGN DATE	3-8-01	BY: MSR	ALSO SHOWN: 08029027 EXTRUSION KIT PART NUMBER DRUM KIT 08029026		
DATE		3-8-01	DIMENSIONS: MILLIMETERS		SCALE: NONE	GEN. TOL. NONE	PROFURL BASIC GENOVA RF SYSTEM O393		

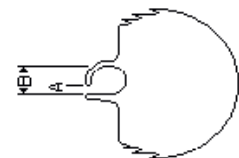

DIMENSION mm	A	B
LUFF GROOVE	2.6	5.8

Headsail Specification and Technical Worksheet					
Model Type:		Beneteau Oceanis 393 USA			
Sail Type:		Roller Furling Genoa			
"I" Dim:	14050	"J" Dim:	4430	Max Hoist:	13850
		Area:	11.25sqmt		
Finished Dimensions					
Luff:	13700	Leech:	12936	Foot:	6547
		L.P.:	6202 / 140%		
Finish Details					
Material Type:	6.9 SuperCruise		Tack Detail:	Double webbing Loop	
Head Detail:	Double Webbing Loop		Clew Detail:	50mm ext ring with Leather	
Foam Luff:	Multi track foam luff system™		Trim Stripe	2 sets, 2 x 3/8" green	
Tell Tale:	Yes, 3 sets		T-tale Window:	12" round	
Leech/foot:	25 mm single fold tabling		Foil Tape:	NP#5	
Leech Cleat:	241 Alum. Cleat with snubbing eyes		Foot Cleat:	2 #3 eyelets at tack	
Bag Type:	Drawstring type "C"		Seam:	V-92 blue 2 x 3step	
U.V. Cover:	Yes, Starboard	Cover Material/Colour:	White U.V. Mark Cloth		
Furling System:	Profurl B35S				
Drawing Information					
Drawn By:	Bob	Date:	May- 2001	Rev #:	08081393-R000.DOC
Additional Notes:	1 ST PRODUCTION SAIL				

Tack/Reefing Detail:

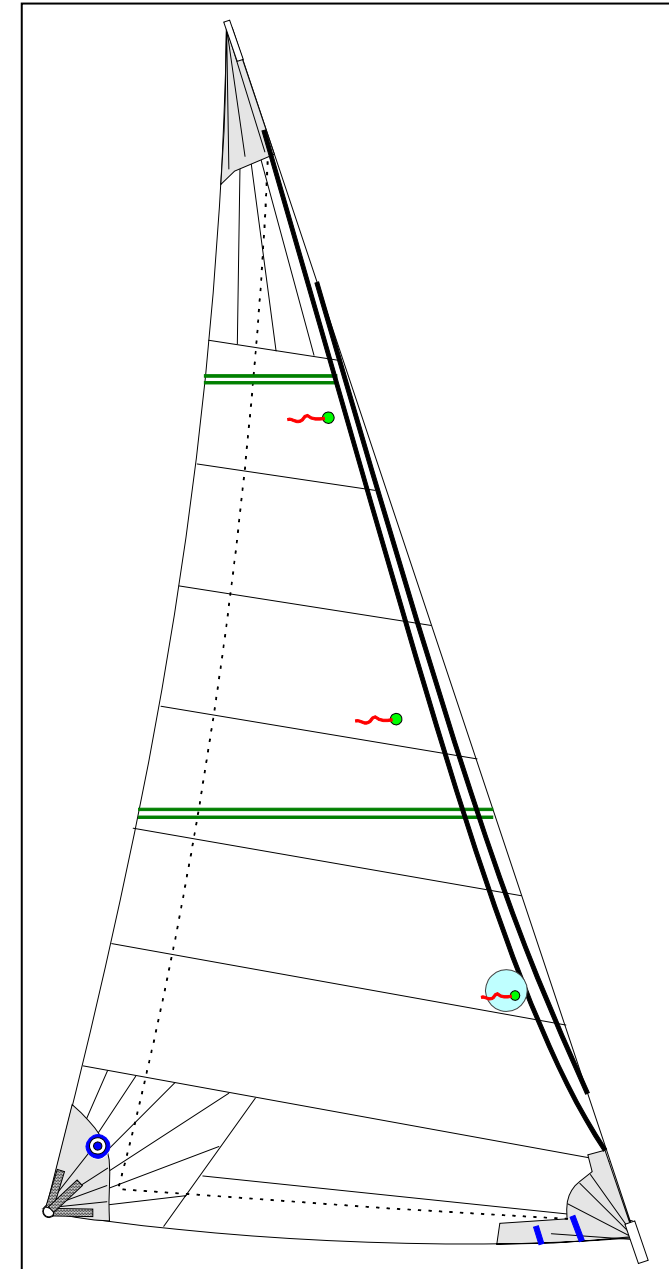
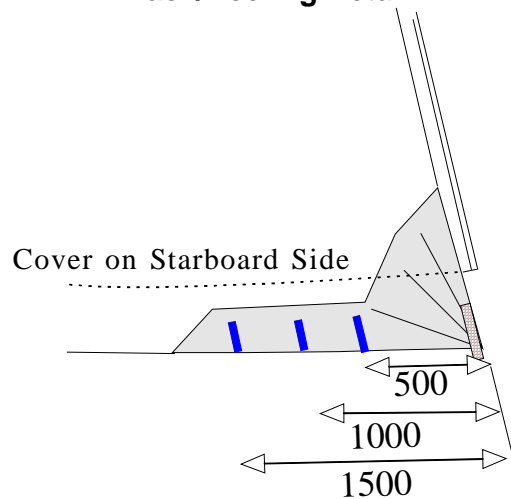

Mainsail Specification and Technical Worksheet							
Model Type:		<i>Beneteau Oceanis 393 USA</i>					
Sail Type:		<i>Roller Furling Mainsail</i>					
"P" Dim:	12200	"E" Dim:	4600	Sailmaker "E"	4550	Area:	25.6sqmt
Finished							
Luff:	12050	Leech:	12390	Foot:	4508		
Finish							
Material Type:	<i>8.03 Challenge</i>		Tack Detail:	<i>Single ply 25mm webbing loop</i>			
Head Detail:	<i>Single ply 25mm webbing loop</i>		Clew Slug/Car:	<i>Z-spar 3259 Clew block</i>			
Clew Detail:	<i>Pg 38 safety clew ring with webbing</i>		Insignia:	<i>Yes, black</i>			
			Seams:	<i>3 rows 3step, Blue V92</i>			
Draft Stripe:	<i>Yes, 2x3/8" green</i>		Tell Tale:	<i>Yes</i>			
Leech Cleat:	<i>241 Alum cleat with snubbing eyes</i>		Bag Type:	<i>Drawstring type "B"</i>			
Luff Rope	<i>NPS#6 Foil Tape</i>		Cover Material/Colour:	<i>Clew only, both sides: UV mark cloth / white</i>			
Mast Section:	<i>Z-Spar: Z600E</i>		Boom Section	<i>Z-spar: Z360</i>			
Tack and Clew Cutback							
A:		B:		C:		D:	
				E:	50	F:	
						G:	
Drawing							
Drawn By:	<i>Bob</i>		Date:	<i>May-01</i>		Revision #	<i>08071393-R001.doc</i>
Additional Notes:	<i>Finished Dimensions include head and tack webs. Rev 1: adjusts foot length</i>						

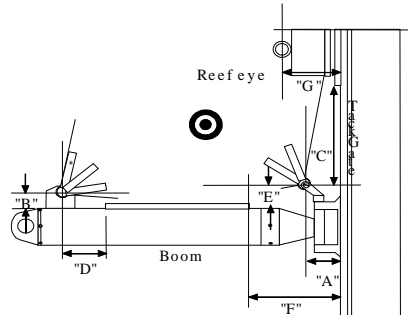

Tack/Clew Detail

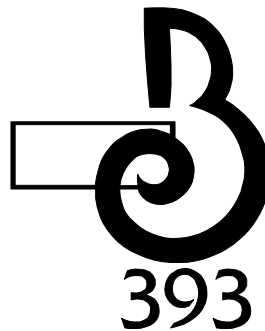

Black

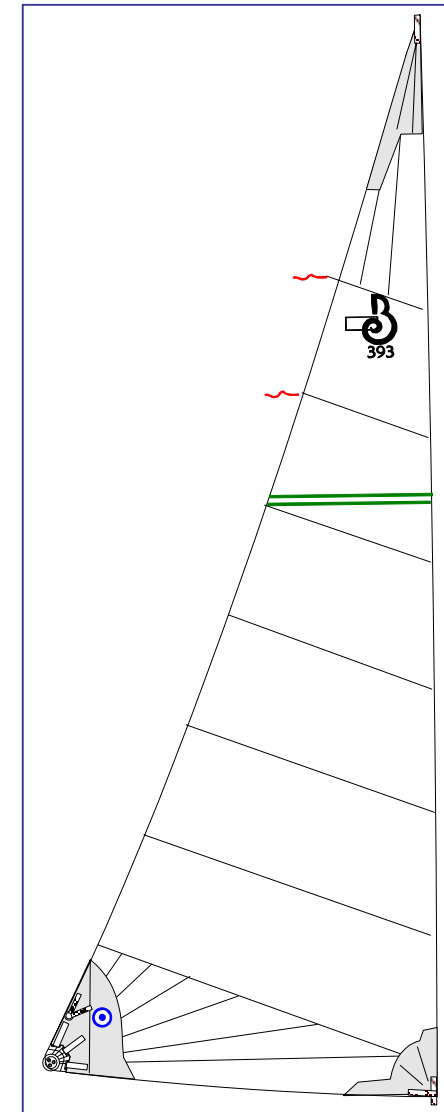

Beneteau Part #: 0807 1393

Mainsail Specification and Technical Worksheet													
Model Type:		Oceanis 393 U.S.A.											
Sail Type:		Classic Mainsail Series 2002											
"P" Dim:		12300	"E" Dim:		4600	Area:		31.5sqmt					
Finished Dimensions													
Luff:		12200	Leech:		12840	Foot:		4572					
Finish Details													
Material Type:		8.9 SuperCruise			Tack Detail:		40mm SS Ring with leather						
Head Detail:		50mm s.s. Ring with leather			Clew Slug/Car:		SLD151 (B102) Cast Slug						
Head Slide:		SLD151 (B102) Cast Slug			Clew:		50mm s.s. Ring with leather						
Clew Reef 1:		34118 Wichard block on starboard Side led through PG 23 ring			Tack Reef 1:		33118 Wichard block on starboard Side led through PG 20 ring						
Clew Reef 2:		34118 Wichard block on starboard Side led through PG 23 ring			Tack Reef 2:		33118 Wichard blocs on starboard Side led through PG 20 ring						
Sail Ties:		Yes, 3 x 2.4 mt ties			Logos		2 bullseyes						
Battens:		4 x 40mm flat			Ben. Part#:		08070028						
Bat. Lengths:		#1	1180	#2	2180	#3	3134	#4	3880	#5	n.a.		
Batten Slides:		A014 Seldon Allslip			Battens stops		4- A303						
Leech Cleat:		241 Alum. With snubbing eyes			Luff eyes:		5-#3 eyelets						
Luff Tape:		5" with 10mm rope			Insignia:		Yes						
Leech Line:		4mm Dacron line			Bag Type:		Drawstring type "C"						
Reef Cleat:		2 x 241 Aluminum			Tell Tale:		4 - 1 at each batten						
Reef heights in % of "P"		Reef 1	15%	Reef 2	34%	Reef 3	na						
Luff Slides:		5- 662A LG Seldon slides			Foot Tape:		Double Tabling						
Seams:		3 rows V-92 blue 3-step			Trim stripes:		2 x 3/8" green						
Reefing slots:		n.a. loose foot			Reef eyes:		7 # 3 eyelets						
Mast Section:		Z-Spar: 601			Boom Section:		Z-Spar Z360						
Tack and Clew Cutback Details:													
A:	50	B:	000	C:	350	D:	000	E:	20	F:	280	G:	65
Drawing Information													
Drawn By:		Bob		Date:		Aug 2001		Rev#		0807-1394-rev001		mainsail.doc	
Additional Notes:		Production Model 1-A Classic Main Rev 1: Changes to full battens.											

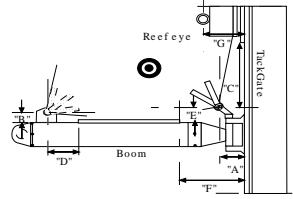

Tack/Clew Detail

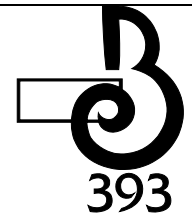

Insignia Detail in Black

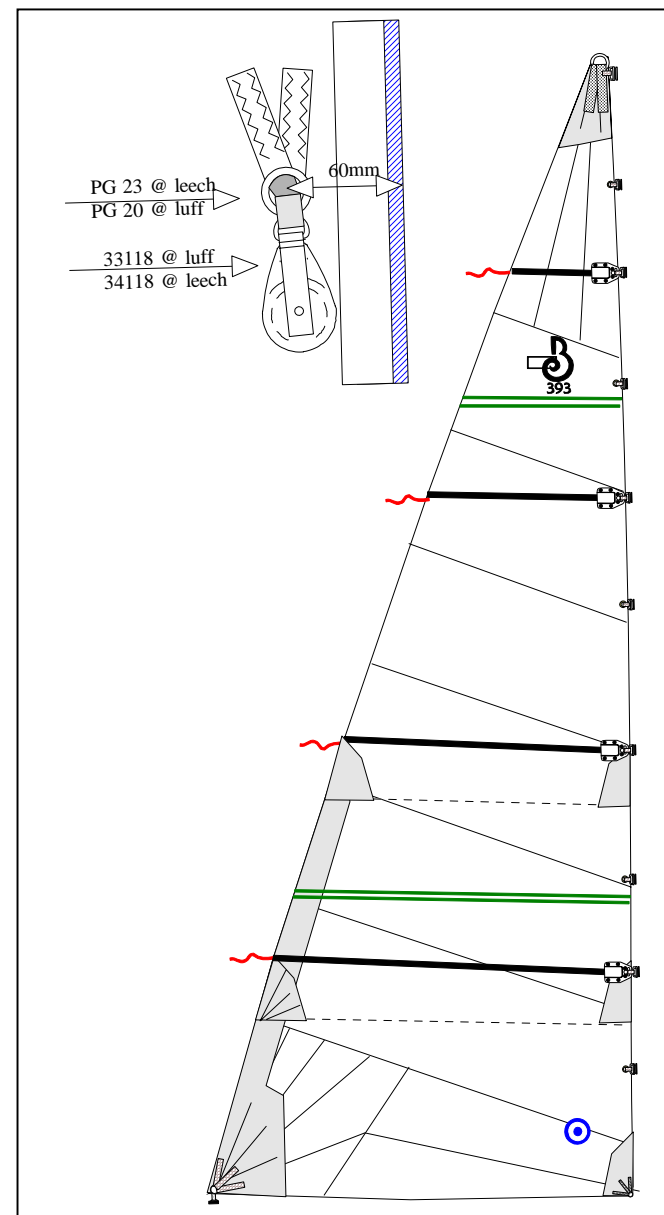

DECK LAYOUT FOR ROLLER FURLING MAST (STANDARD)

REF	STANDARD MAST	OPTIONAL
1	Main Halyard	
2	RF Main Outhaul	
3	RF Main Inhaul	
4	Mainsheet	
5	Vang	
6		Foreguy
7		Spinnaker/Genneker Halyard
8		Spinnaker pole topping lift

LINES THROUGH DECK ORGANIZER

..... Upper Sheave

———— Lower Sheave

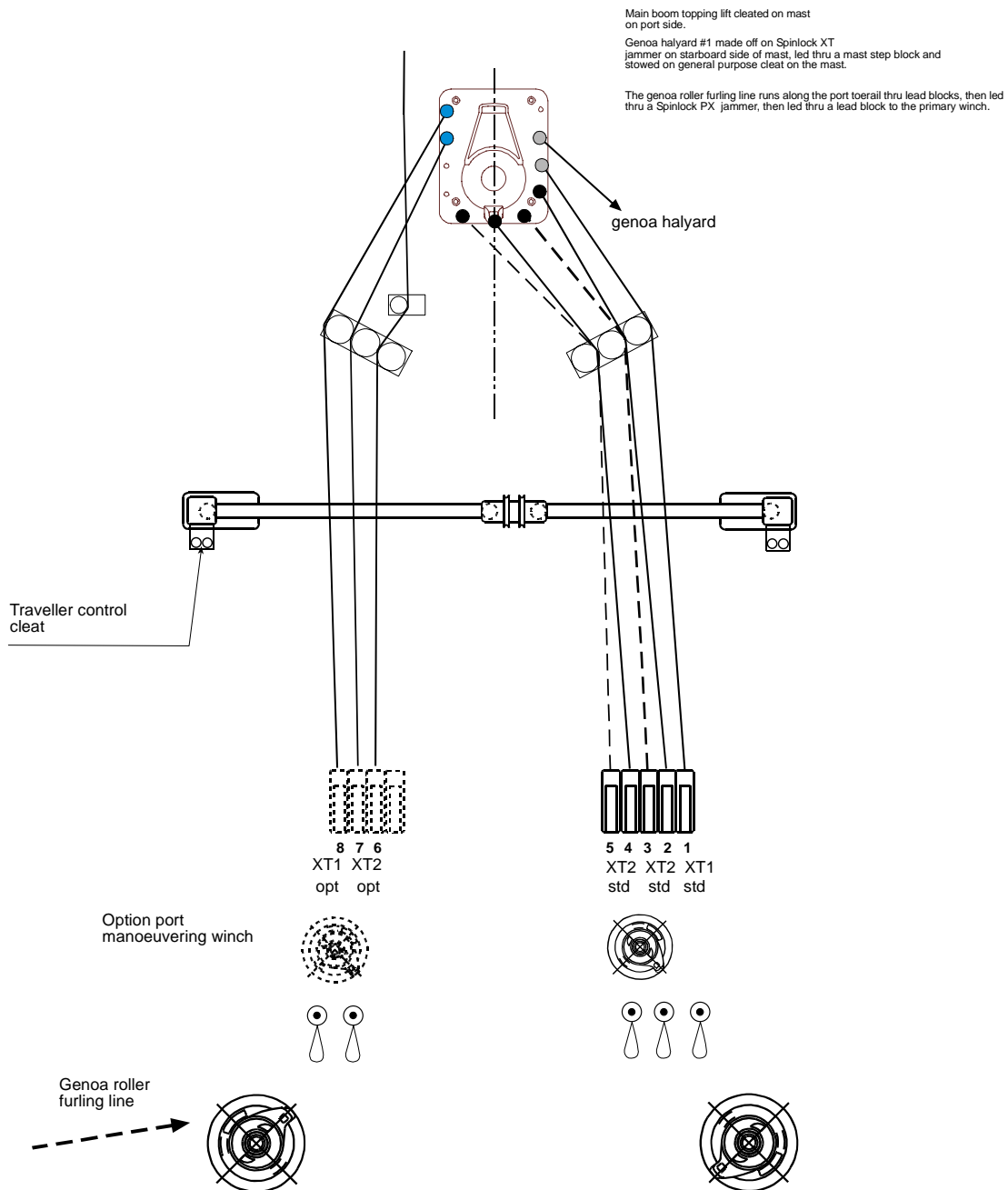

DECK LAYOUT FOR CLASSIC MAST (OPTION)

REF	STANDARD MAST	OPTIONAL
1	Main Halyard	
2	Reef 2	
3	Reef 1	
4	Mainsheet	
5	Vang	
6		Foreguy
7		Spinnaker/Genneker Halyard
8		Spinnaker pole topping lift

LINES THROUGH DECK ORGANIZER



Upper Sheave



Lower Sheave

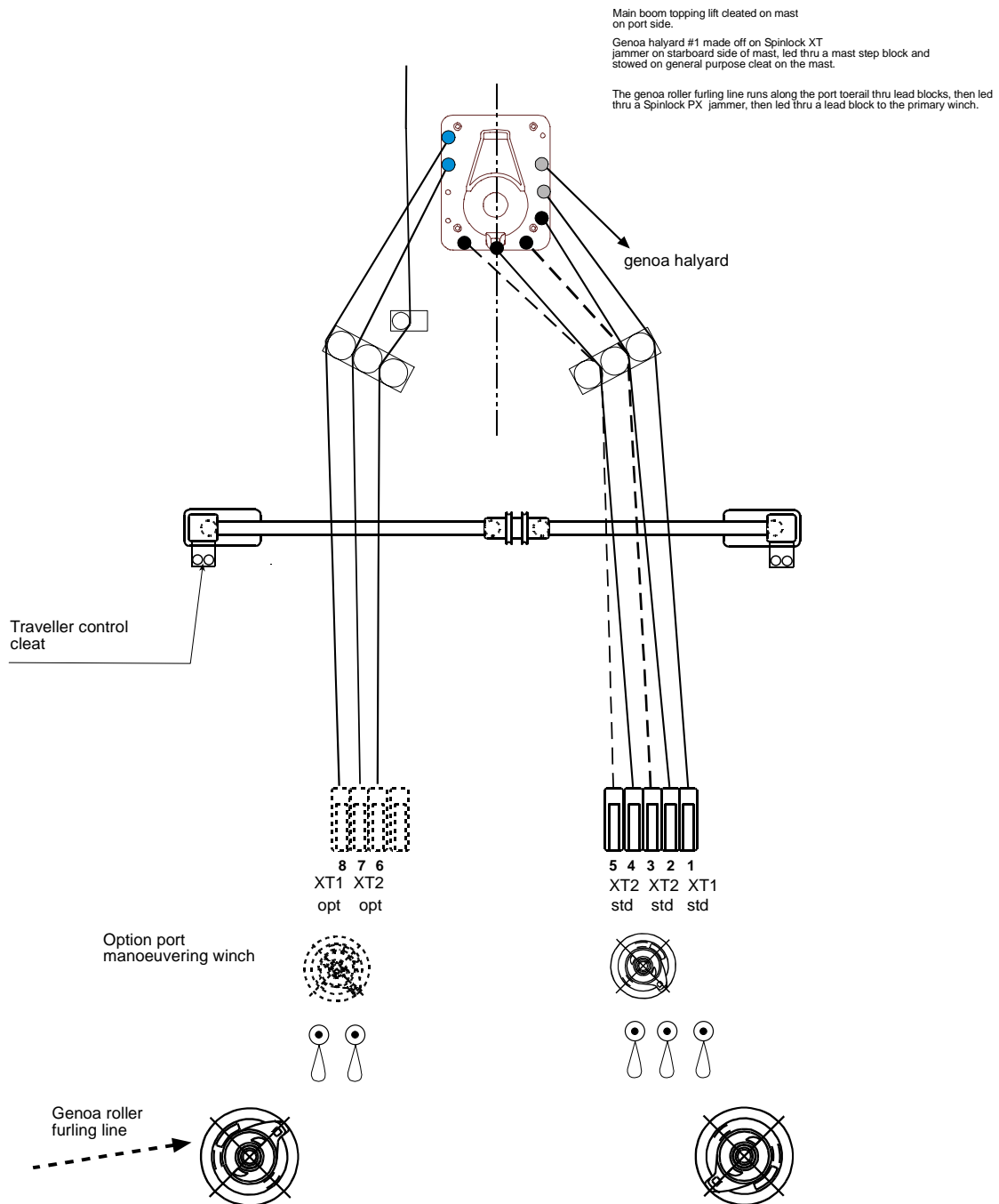

MAINSAIL TACKLE AND REEFING SYSTEM

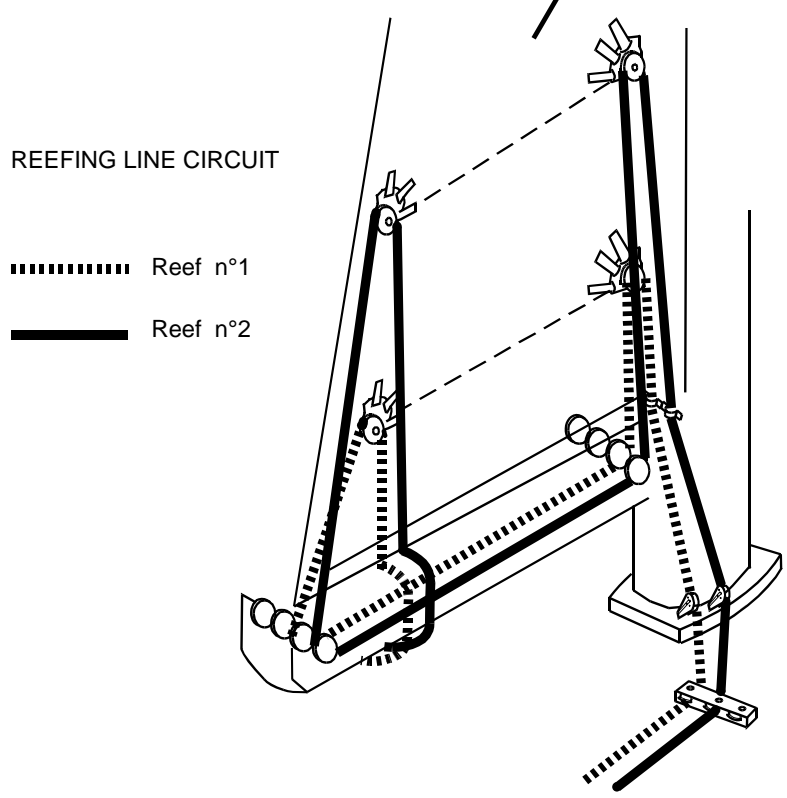
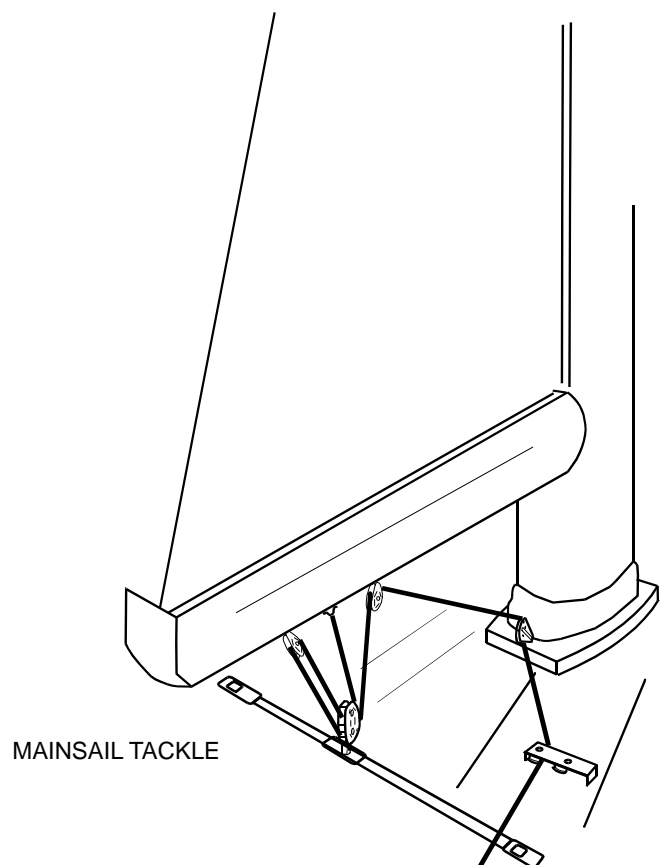

XIV) FRESH WATER SYSTEM

REF	DESCRIPTION
1	Bow Water Tank 250 L (66 US gal)
2	Aft Stbd Water Tank 250 L (66 US gal)
3	Deck Fill – Fresh Water Tank
4	Vent – Fresh Water Tank
5	Water Tank Manifold
6	Filter
7	Fresh Water Pump
8	Water Heater [capacity : 22.7 L (6 US gal)]
9	Shower Discharge Pump
10	Filter for Shower Discharge
11	Galley Sink
12	Washbasin/Shower
13	Transom Shower
14	Icebox

The fresh water system supplies the sink in the galley, the wash basin and shower in all of the heads, and the transom shower. This system is pressurized by an electric pump. There is a filter between the water tank manifold and the pump. It is necessary to check and clean this filter regularly.

Never run an electric pump when the tank is empty. It may burn out the pump.

To prevent any over pressure in the system during filling, never force the filling nozzle deep down the filler pipe and keep an eye on the vent hole(s) through which the excess water will be discharged.

When the system has not been used for a long period of time, the tanks and pipes should be cleansed with an acetic acid solution (white vinegar).

The water drains out from the sink and wash basins through their own thru-hulls. Close them when the water system is not used.

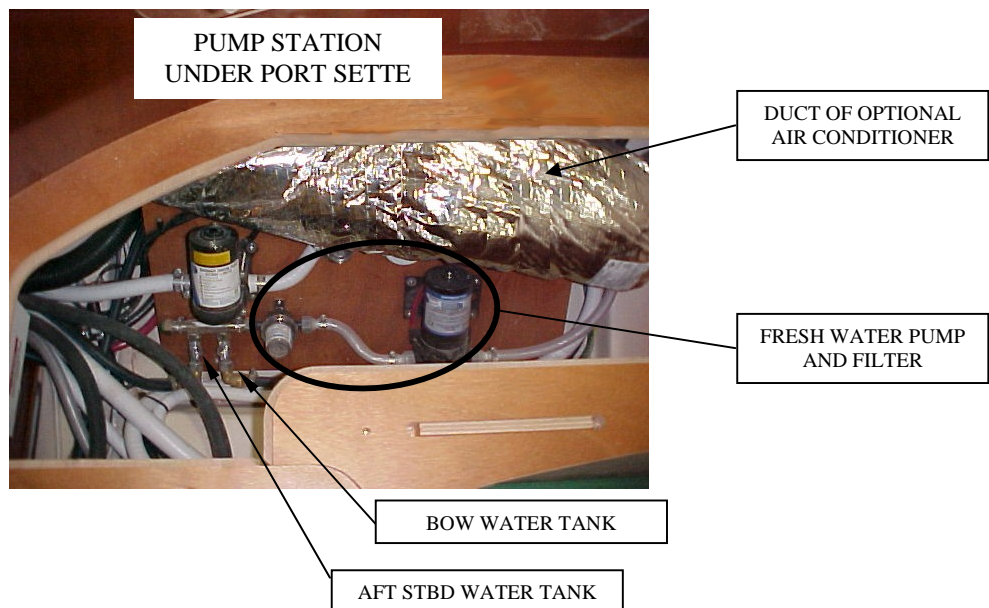

LAY OUT OF THE FRESH WATER SYSTEM

2 cabin / 2 toilet

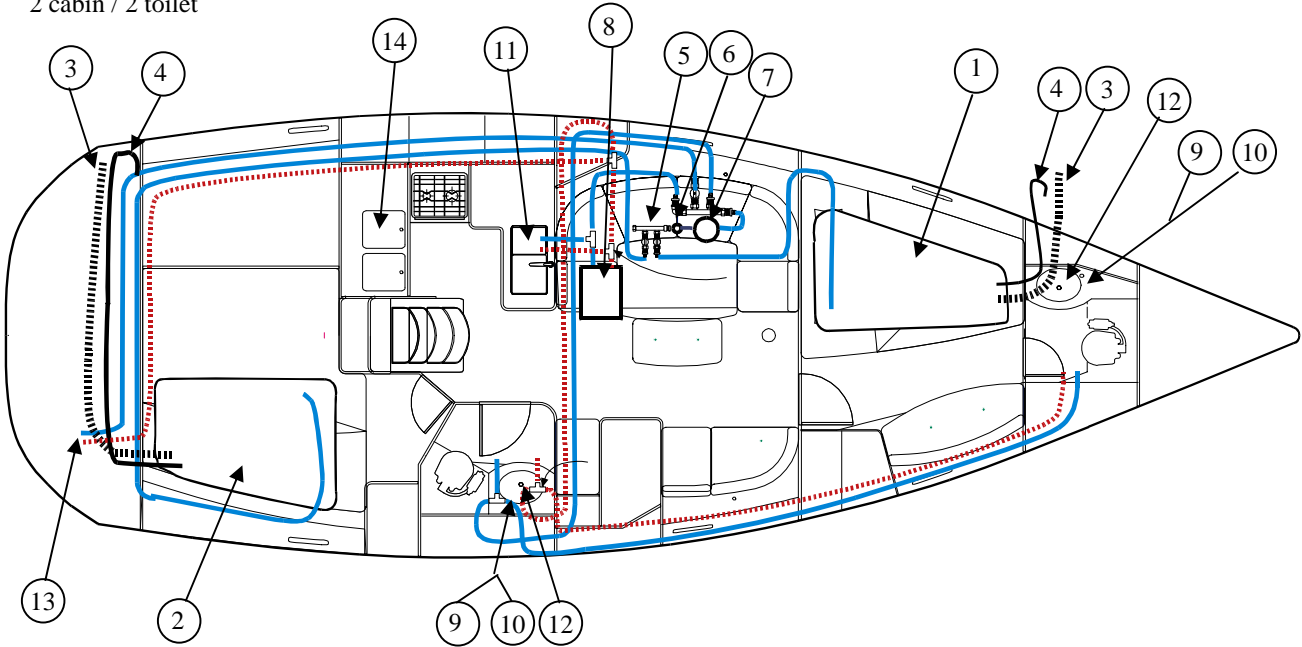

3 cabin / 2 toilet

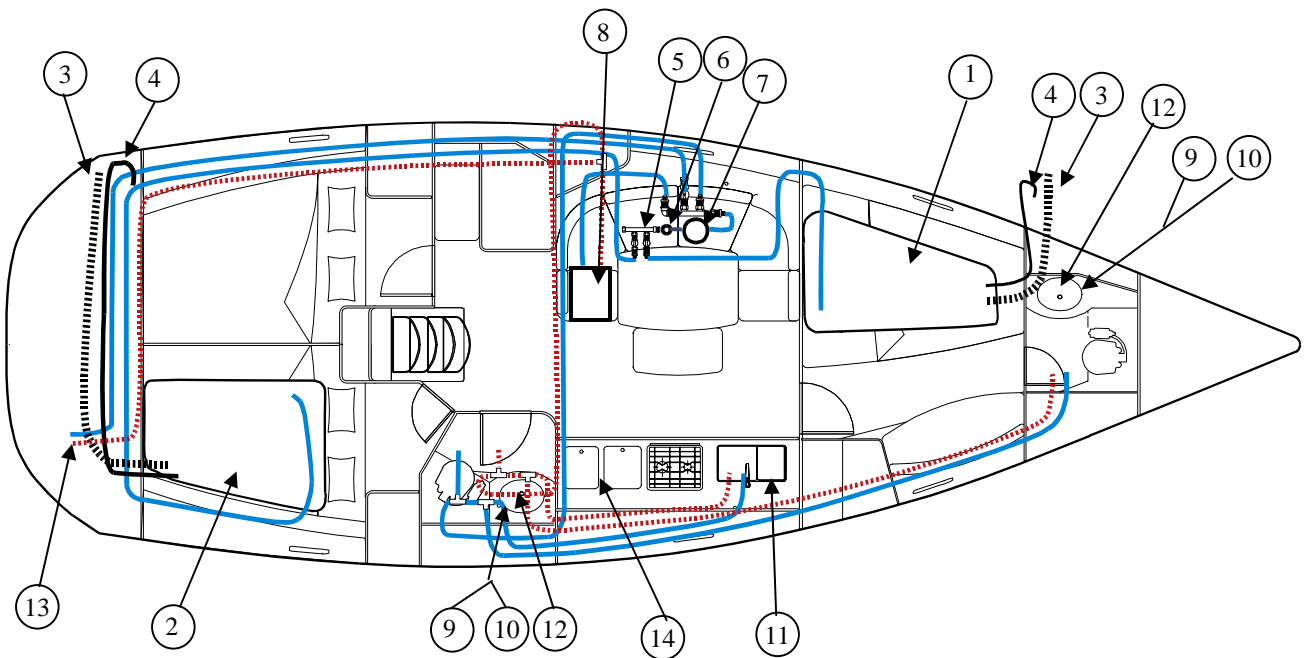

XV) BILGE PUMP SYSTEM

REF	DESCRIPTION
1	Electric Bilge Pump 720 lph (168 gph)
2	Filter of the Electric Bilge Pump
3	Sump
4	Manual Bilge Pump 0.7 l. (.18 US gal.) per stroke
5	Electric Bilge Pump Intake Hose
6	Manual Bilge Pump Intake Hose
7	Electric Bilge Pump Discharge Hose
8	Manual Bilge Pump Discharge Hose

Make sure the bilge pump system is in good working order before you put out to sea.

Acquaint yourself with the way the bilge pump system of your boat works:

- **Locate the manual bilge pump and the handle.**
-
- **Locate the on switch of the electric bilge pump and get to know how the seacocks work (for the boats fitted with an electric bilge pump).**
-

(See the lay out drawing of the system - next page)

Make sure that the bilge pump intake strainer is not blocked with dirt.

Regularly clean the intake strainer on the sump and the filter of the system.

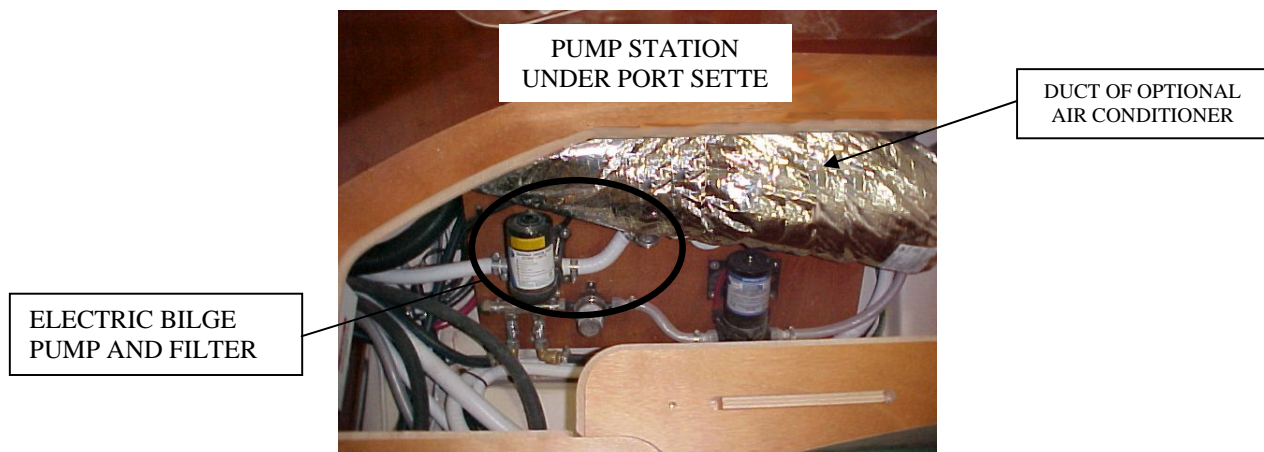

LAY OUT OF THE BILGE PUMP SYSTEM

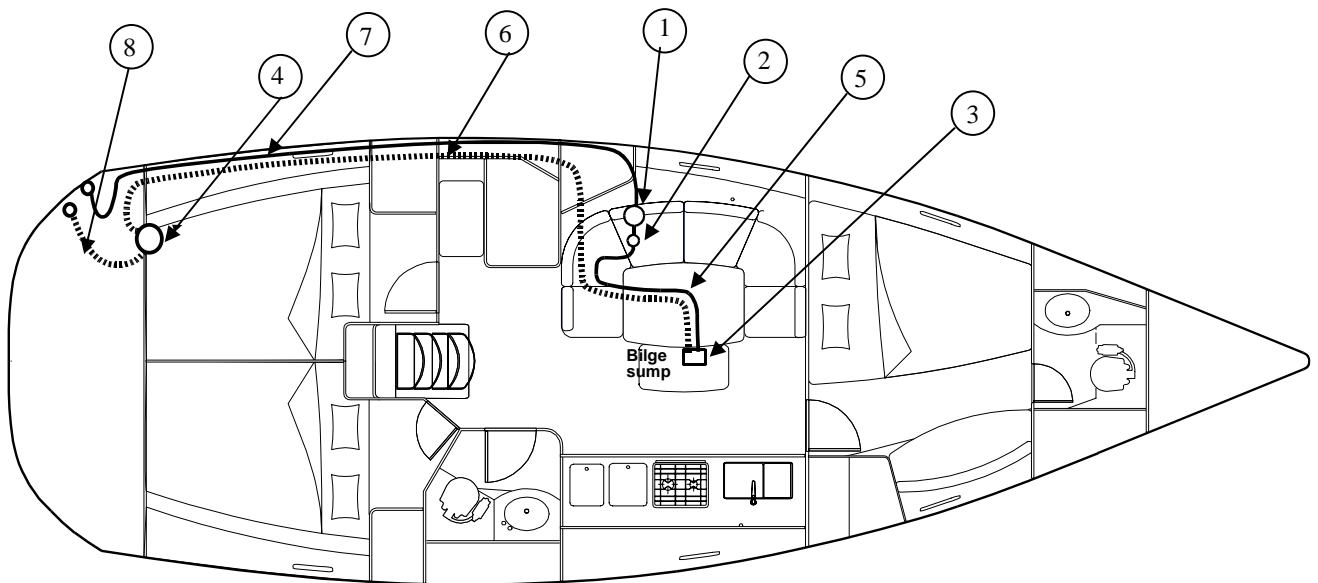
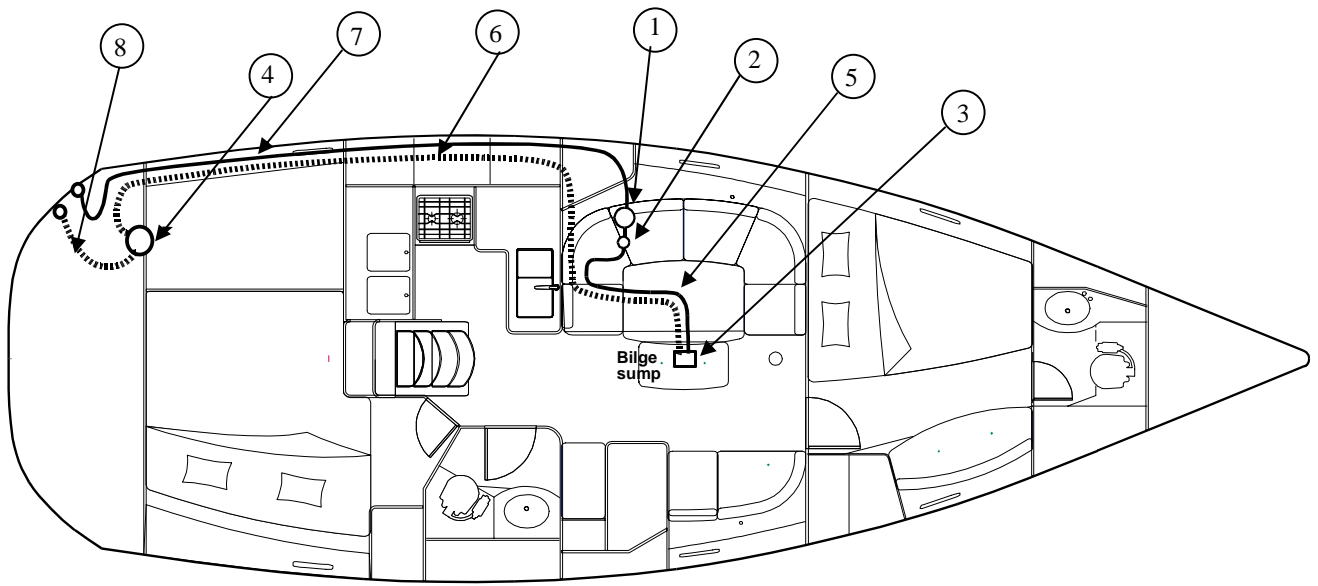

XVI) SEACOCKS AND THRU-HULLS

Close all the seacocks when you leave the boat.

The toilet is situated below the waterline; get into the habit of systematically closing the seacocks after each use.

Make sure that all seacocks, which are not used, are closed before you put out to sea.

Opening and closing of the seacocks

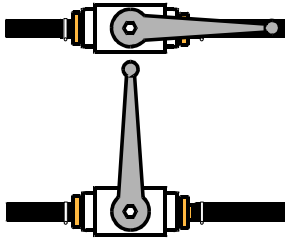

Open

Closed

REF	DESCRIPTION
1	Head Discharge
2	Head Intake
3*	Washbasin Discharge
4	Shower Discharge
5	Galley Sink Discharge
6	Engine Cooling Water Intake
7	Ice Box Draining
8	Stern Tube Cooling Intake Valve
9	Speed/Log, Depth Sounder Thruhulls
10	Waste Tank Drain (optional)

* The washbasin and shower discharge, connect to the same thru hull through a set of 1/4 turn valves and a tee. The washbasin discharge will be the one with a slightly larger diameter hose.

Operation of three-way valve for toilets

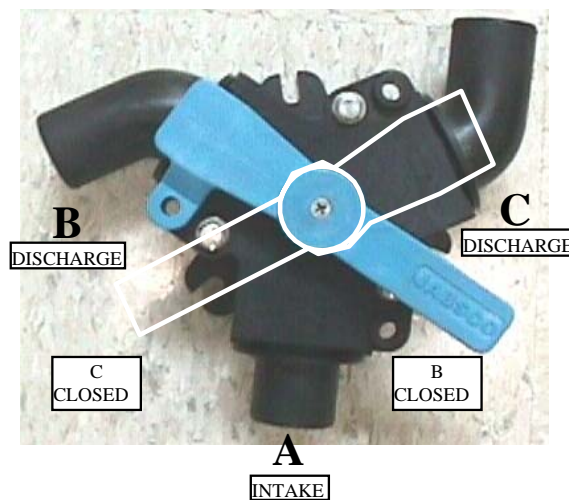

SEACOCK AND THRU-HULL LAY OUT

2 cabin / 2 toilet

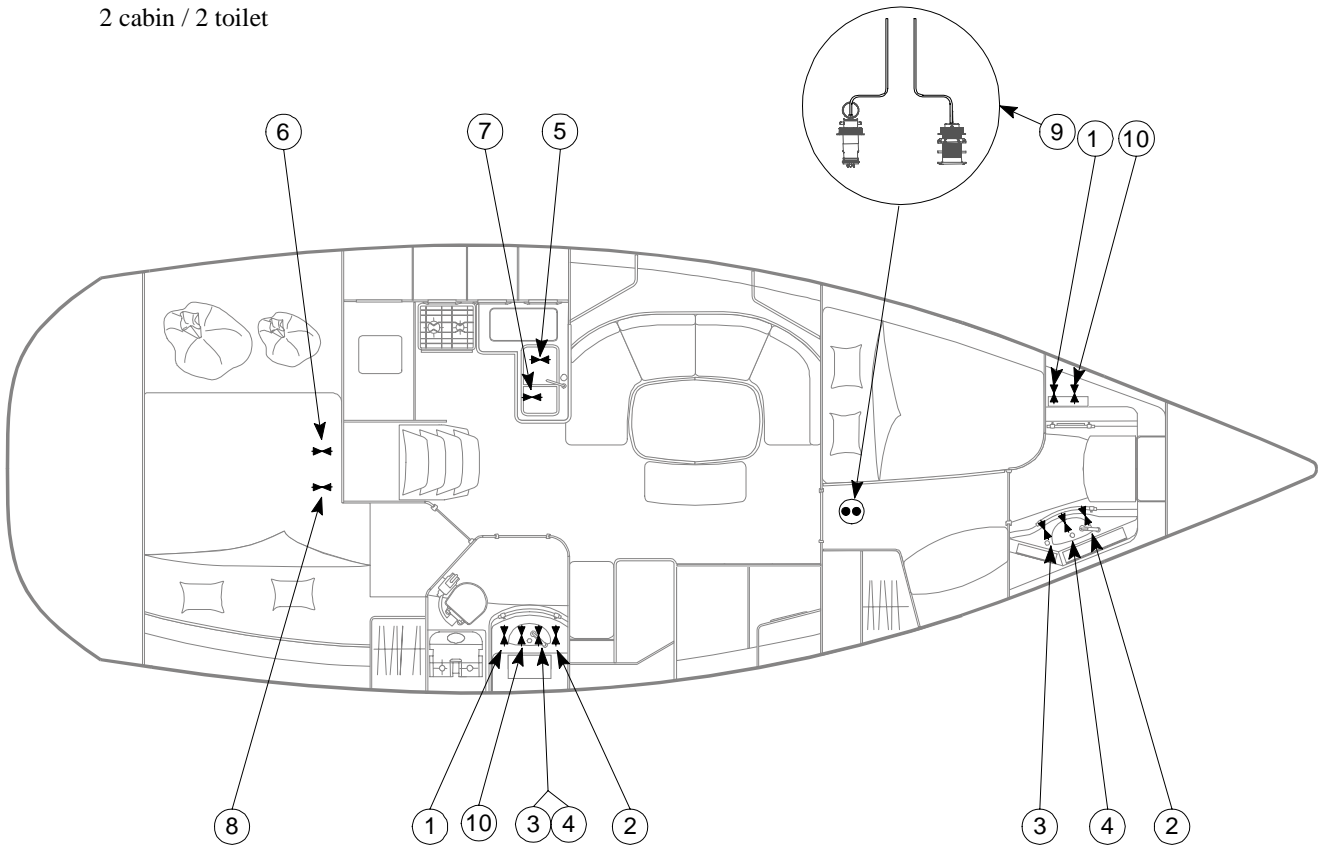

3 cabin / 2 toilet

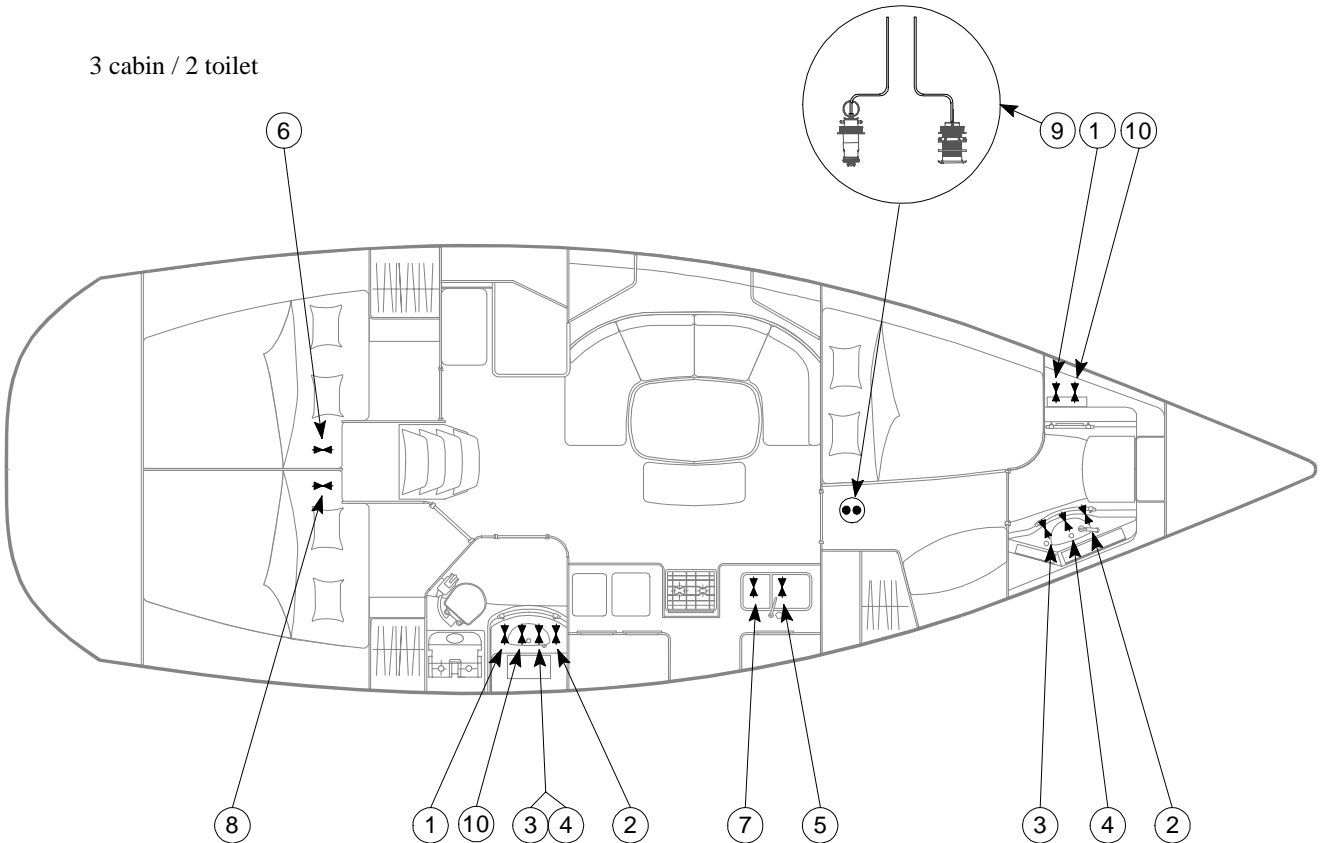

XVII) ELECTRIC SYSTEMS

When the voltage is not specified, all the functions or panels are in 12 Volts.

12V Electric System

Never work on a live electric fitting.

Never tamper with an electric fitting. Call in a technician qualified in marine electricity.

The batteries must be carefully and safely stowed.

In order to prevent a short circuit between the battery terminals, do not store conductive objects near the batteries (e.g. metal tools, ...)

Never alter the specifications of the breakers, which protect against overload.

Never fit or replace the electric materials or appliances with components, which exceed the system amperage.

110V-220V Electric System

Boats are fitted with a 110V/60Hz or a 220V/50Hz system (some as standard, others as an option, depending on the models). We advise you to follow these steps in order to avoid the risk of electric shock and fire.

Do not work on a live fitting.

Connect the boat / shore supply cable to the boat before you plug it into the shore supply socket with the breaker off. Turn the breaker on last.

Do not immerse the boat / shore cable socket.

Turn off the shore supply switch on board before you plug in or unplug the boat / shore supply cable.

Do not tamper with the connections of the Boat / shore supply cable. Use only compatible connections.

Never swim in a marina around boats connected to shore power. If necessary for maintenance unplug the boat being worked on and surrounding boats.

BATTERY SWITCH OPERATION

Never turn the negative battery switch off while engine is running.

Never turn all positive switches off while engine is running.

Battery 1 is the engine / start battery

Battery 2 is the service / house battery

Negative battery switch controls ground {DC12V negative} for all batteries.

To charge a battery with the engine the positive switch must be in the on position.

WARNING: Do not turn both positive battery switches off while engine is running

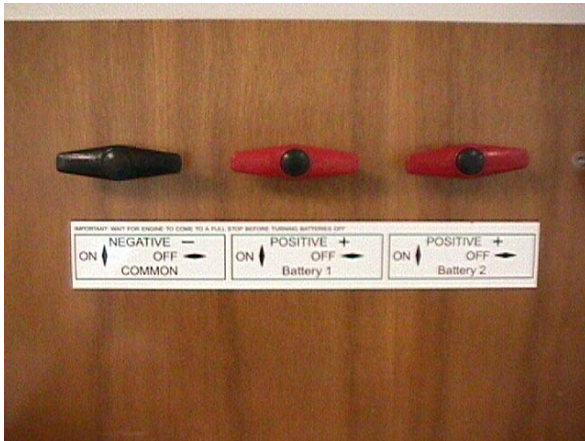

Everything is OFF, no 12V DC power
(when leaving the boat unattended)



Everything is ON, 12VDC power available
to start engine and/or run equipment

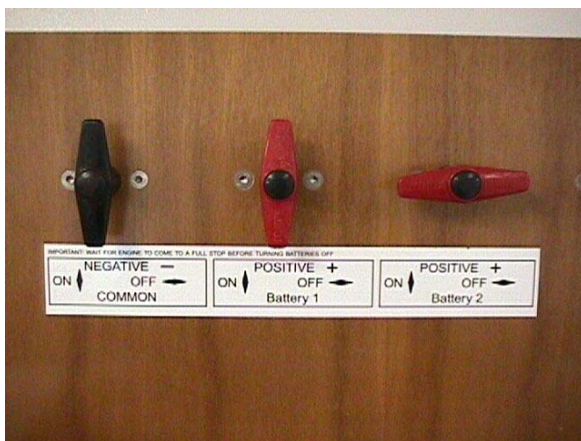

Configuration to start engine ,while
house/service is off or down

You can turn house switch ON, while
engine is running to charge house.



Engine is off , Run equipment from house only
(like at anchorage)

ELECTRICITY LAY OUT

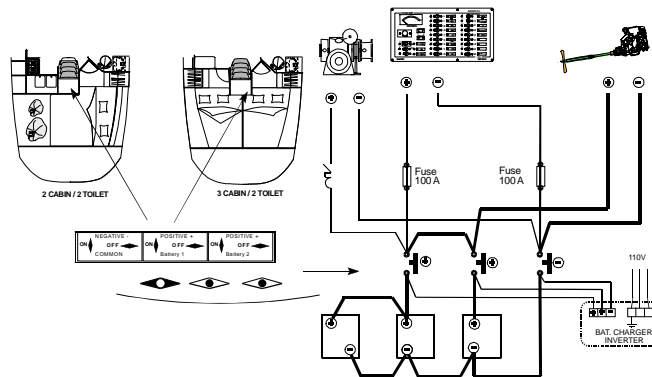
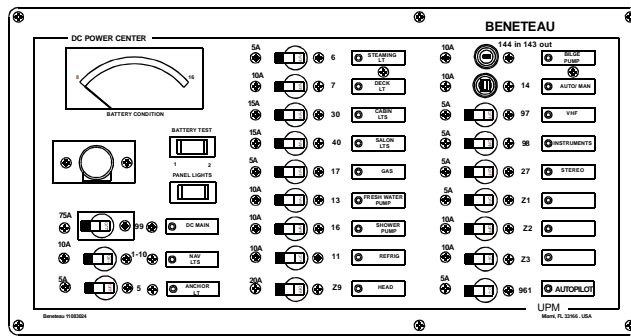

12V PANEL

FUNCTION	BREAKER AMPERAGE (Amp)
Main	75
Navigation Light	10
Anchor Light	5
Steaming Light	5
Deck Light	10
Cabin Lights	15
Salon Lights	15
Gas Valve	5
Water Pump	10
Shower Pump	10
Refrigeration	10
Head	20
Bilge Pump	10
VHF	5
Instruments	5
Stereo	5
Spare qty 1	5
Spare qty 2	10
Autopilot	5 *

110/220V PANEL

FUNCTION	BREAKER AMPERAGE (Amp)
Water Heater	15
Battery Charger	10
Outlets	15

* Note: Autopilot 5A breaker feeds a relay

LAY OUT OF THE 12V LIGHTS AND APPLIANCES

REF	DESCRIPTION	FUNCTION ON PANEL
1	Bicolor Bow Navigation Light	Navigation Lights
10	White Stern Navigation Light	Navigation Lights
4	Tri-color mast head light (on mast)	Navigation Lights
5	Anchor Light (on mast)	Anchor Light
6	Steaming Light (on mast)	Steaming Light
7	Deck Light	Deck Light
30	Ceiling Light	Cabin Lights
32	Ceiling Light	Cabin Lights
34	Ceiling Light	Cabin Lights
35	Ceiling Light	Cabin Lights
40	Ceiling Light	Salon Lights
41	Ceiling Light	Salon Lights
42	Ceiling Light	Salon Lights
43	Red Nav Light-2 cabin Ceiling Light-3 cabin	Salon Lights
44	Flourescent Light-2 cabin Red Nav Light-3 cabin	Salon Lights
45	Ceiling Light	Salon Lights
48	Ceiling Light-2 cabin Red Nav Light-3 cabin	Cabin Lights
49	Ceiling Light	Salon Lights
50	Ceiling Light	Salon Lights
52	Ceiling Light	Salon Lights
53	Reading Light	Cabin Lights
54	Reading Light	Cabin Lights
55	Ceiling Light	Cabin Lights
56	Reading Light	Cabin Lights
57	Reading Light	Cabin Lights
59	Reading Light	Cabin Lights
61	Reading Light	Salon Lights
62	Reading Light	Cabin Lights
63	Reading Light	Cabin Lights
9	Compass Lights	Instrument Lights
13	Fresh Water Pump	Fresh Water Pump
14	Bilge Pump	Bilge Pump
11	Refrigeration	Refrigeration
161	Shower Pump – Fwd Toilet	Shower Pump
162	Shower Pump – Port Aft Toilet	Shower Pump

ⓘ = Light Switch

12V LIGHT AND APPLIANCE LAY OUT

2 cabin / 2 toilet

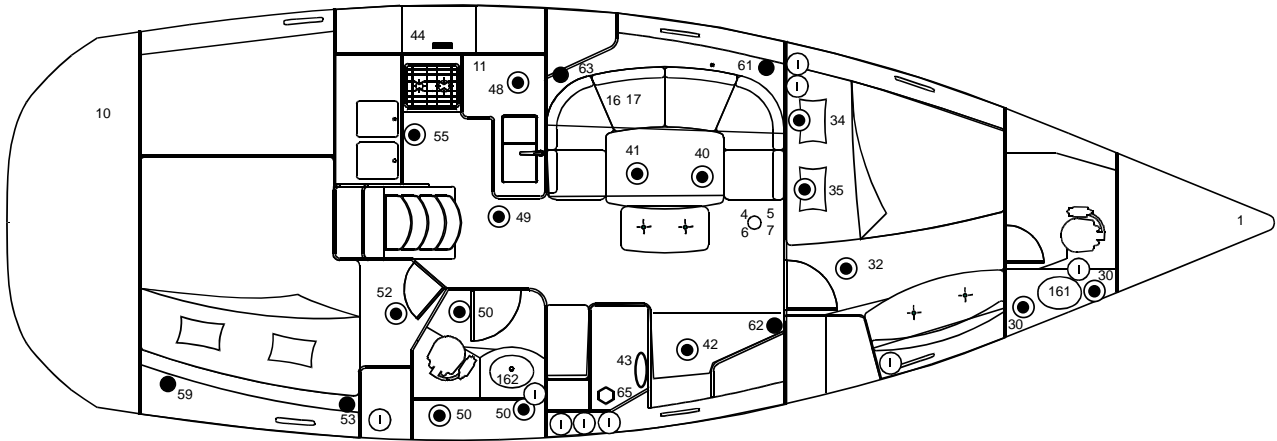

3 cabin / 2 toilet

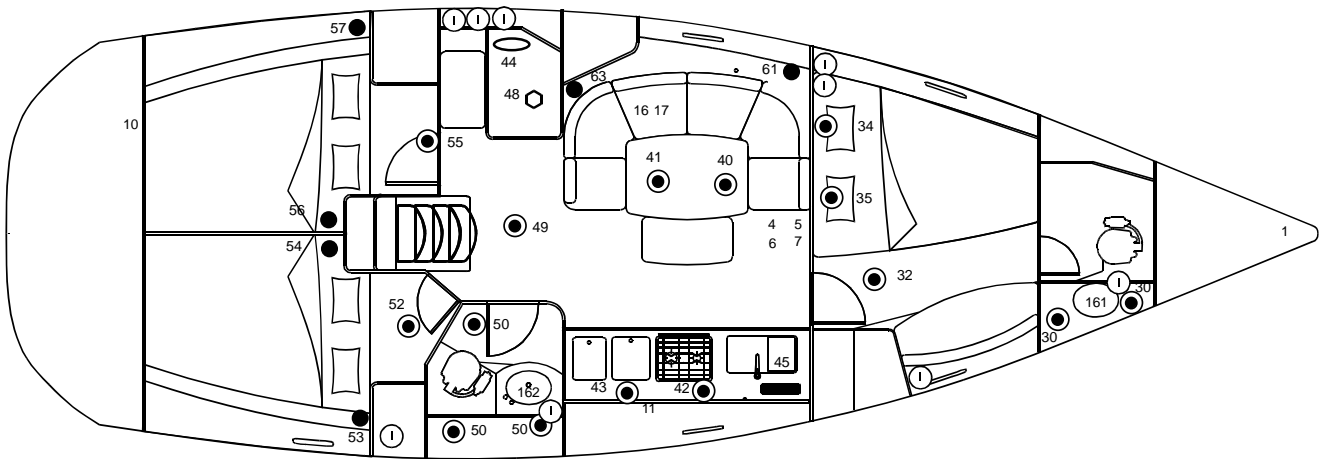

LOCATION OF 110 / 220V SOCKETS AND APPLIANCES

REF	DESCRIPTION
1	Shore Power Inlet
2	Battery Charger
3	110/220V Outlet
4	Water Heater

2 cabin / 2 toilet

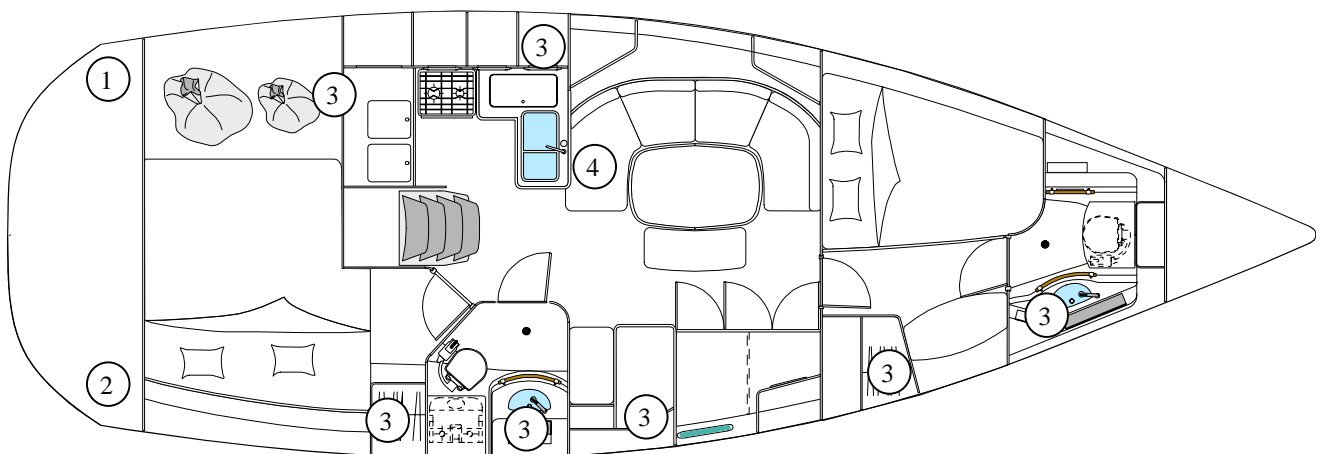

3 cabin / 2 toilet

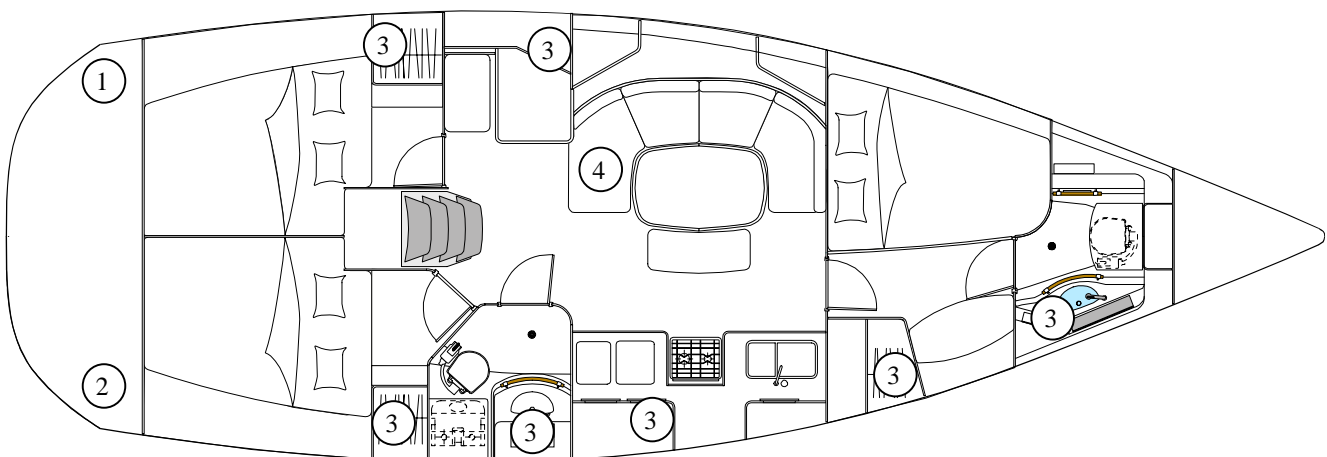

HULL HARNESS LAYOUT

2 Cabin / 2 Toilet Version

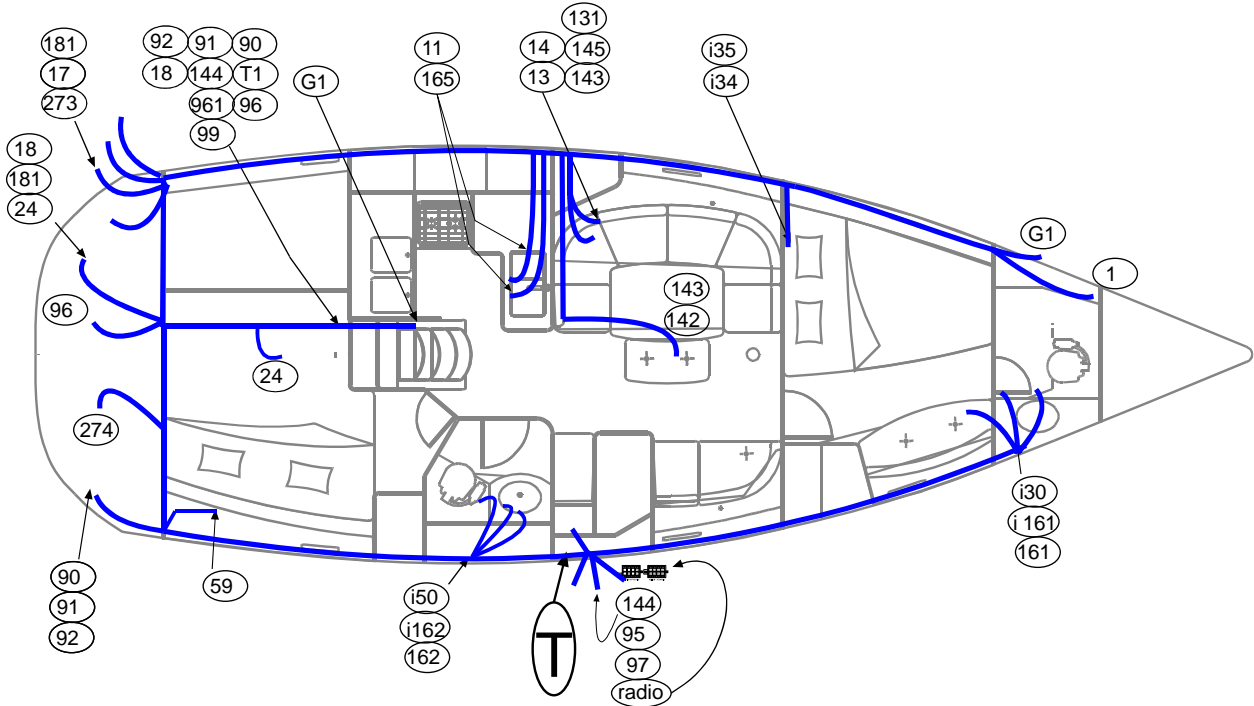

WIRE #	SIZE	AWG	COLOR	L. (m)	Code	NOTE	DESIGNATION
59	2x1.5	R/B	6.600			Not by the panel	Aft reading light STBD aft cabin
96	8x2	R/B	6.000				12V autopilot
961	14x2	R/B	10.700				Autopilot relay
144	14x2	R/B	10.500			Not by the panel	Constant power bilge pump
99	4x2	R/B	10.700				12V Main feed
T1	16x1	R/B	10.700				Battery test
181	14x2	R/B	6.300			Not by the panel	Exhaust fan panel to fan
18	14x2	R/B	7.300			Not by the panel	Exhaust fan BSW to panel
24	16x2	R/B	5.000			Not by the panel	Fuel gauge
274	16x2	R/B	9.500			Not by the panel	STBD outside speaker
162	14x2	R 5.200 B 2.800					Aft shower drain pump
1	16x2	R/B	16.800			on connector	Bow light
G1	16x2	R/B	13.900			Not by the panel	Elec windlass relay feed
161	14x2	R 9.400 B 6.800					FWD shower drain pump
95	16x2	R/B	1.600				Nav Instruments
97	16x2	R/B	1.600				12V V H F
270	16x2	R/B	0.200			Not by the panel	Memory stereo
27	16x2	R/B	2.100				12V stereo
272	16x2	R/B	1.700			Not by the panel	STBD salon speaker
271	16x2	R/B	1.700			Not by the panel	Port salon speaker
50	16x2	R/R	3.000				STBD aft toilet ceiling light switch
30	16x2	R/R	6.900				FWD toilet ceiling light switch
5,6,7	16x3	R	0,80			on connector	Mast lights
WIRE #	SIZE	AWG	COLOR	L. (m)	Code	NOTE	DESIGNATION
R	DESCRIPTION	DATE	DIMENSION:		Material:	WISA	
			TOL GEN:		DATE: 04/16/01		
			Beneteau 393				
			Hull Harness - 2C2T		C6		
			BENETEAU USA		Part No:		
			P.O. Drawer 1218		051938-E		
			Marion, SC 29571				
			(803) 423-4201				
THIS DOCUMENT IS - PROPRIETARY AND REPRODUCTIONS MUST BE AUTHORIZED BY BENETEAU DRAWN BY BENETEAU - SPECIFIED AND DESIGNED BY PRODUCT MANUFACTURER.							

279	18x1	R	0.100			Not by the panel	12V for stereo antenna
i35	18x2	R	14.600			Not by the panel	FWD cab reading light switch
i34	18x2	R	14.600			Not by the panel	FWD cab reading light switch
131	14x1	R	12.400				Fresh water pump light (mr/g's)
145	14x2	R/B	12.400				Bilge pump alarm(mrg's)
143	14x1	R	18.400				Bilge pump floatswitch(marion)
142	14x2	R/B	14.400				2d Bilge pump (mr/g's)
165	14x2	R 17.400 B 13.400					Ice box drain pump
11	8x2	R/B	13.900				Fridge
14	14x2	R/B	12.600				Bilge pump
13	14x2	R/B	11.800				Fresh water pump
171	16x2	R/B	14.400				LPG solenoid light (moorings)
273	16x2	R/B	9.500			Not by the panel	Port outside speaker
17	16x2	R/B	9.300				Propane solenoid
92	8x1	R	6.900			Not by the panel	Batt charger to engine battery
91	8x1	R	6.900			Not by the panel	Batt charger to house batteries
90	8x1	B	6.900			Not by the panel	Negative Bat charger
WIRE #	SIZE	AWG	COLOR	L. (m)	Code	NOTE	DESIGNATION
R	DESCRIPTION	DATE	DIMENSION:		Material:	WISA	
			TOL GEN:		DATE: 04/16/01		
			Beneteau 393				
			Hull Harness - 2C2T		C6		
			BENETEAU USA		Part No:		
			P.O. Drawer 1218		051938-E		
			Marion, SC 29571				
			(803) 423-4201				
THIS DOCUMENT IS - PROPRIETARY AND REPRODUCTIONS MUST BE AUTHORIZED BY BENETEAU DRAWN BY BENETEAU - SPECIFIED AND DESIGNED BY PRODUCT MANUFACTURER.							

3 Cabin / 2 Toilet Version

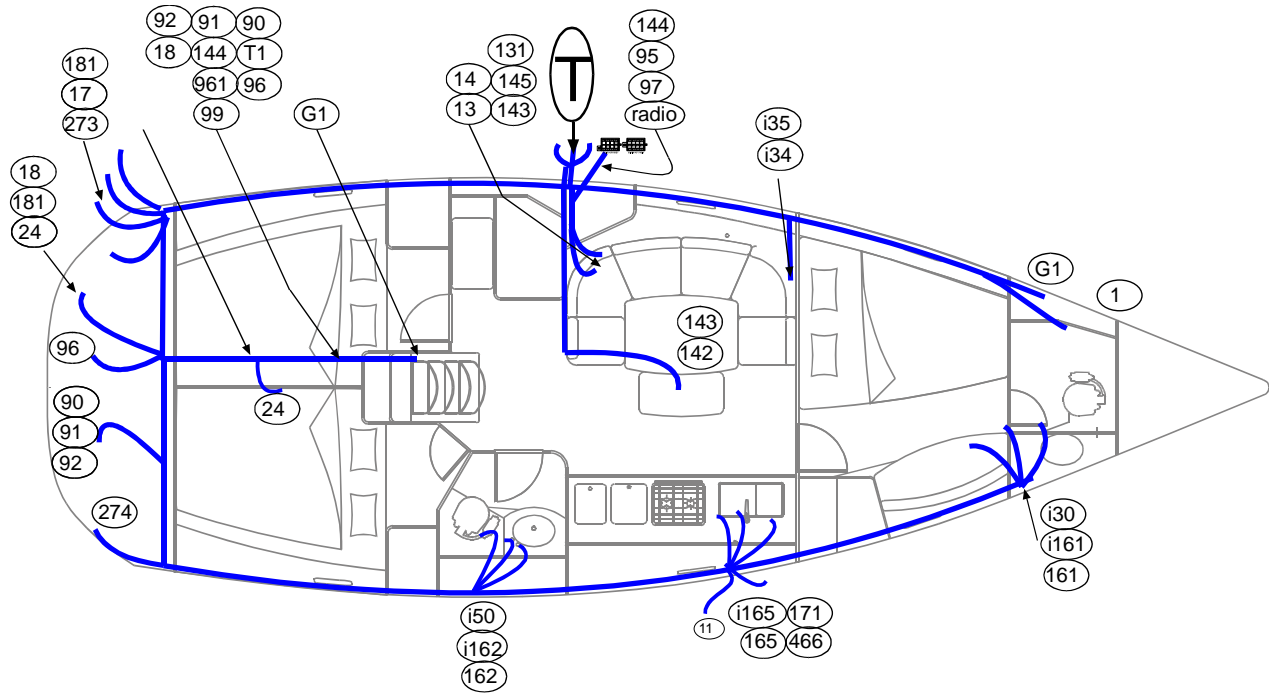

WIRE #	SIZE AWG	COLOR	L. (m)	Code	NOTE	DESIGNATION
T1	16x1	R/B	10.900			Battery test
1	16x2	R/B	8.400		Not by the panel	Bow light
181	14x2	R/B	6.000		Not by the panel	Exhaust fan panel to fan
18	14x2	R/B	7.000		Not by the panel	Exhaust fan BSW to panel
24	16x2	R/B	4.700		Not by the panel	Fuel gauge
17	16x2	R/B	8.200			LPG solenoid
273	16x2	R/B	9.500		Not by the panel	Port outside speaker
G1	16x2	R/B	13.700			Elec.windlass relay feed
i35	16x2	R	6.100		Not by the panel	FWD cabin reading light switch
i34	16x2	R	6.100		Not by the panel	FWD cabin reading light switch
131	14x1	R	3.500			Fresh water pump light (mrg's)
145	14x2	R/B	3.500			Bilge pump alarm (mrg's)
143	14x1	R	8.500			Bilge pump float switch (marion)
142	14x2	R/B	4.900			2d bilge pump (mrg's)
14	14x2	R/B	4.100			Bilge pump
13	14x2	R/B	3.900			Fresh water pump
95	16x2	R/B	1.600			Nav. Instruments
97	16x2	R/B	1.600			12V.VHF
270	16x2	R/B	0.200		Not by the panel	Memory stereo
27	16x2	R/B	1.300			12V stereo
272	16x2	R/B	0.900		Not by the panel	STBD Salon speaker
271	16x2	R/B	0.900		Not by the panel	Port salon speaker
50	16x2	R/R	13.000		On connector	STBDaft toiletceiling light switch
30	16x2	R/R	17.200			FWD toilet ceiling light switch
279	16x1	R	0.100		Not by the panel	12V for stereo antenna
5,6,7	16x3	R	0.800			Mast lights
161	14x2	R	18.800			Fwd shower drain pump
165	14x2	R	17.100			Ice-box frairn pump
171	16x2	R/B	15.100			LPG solenoid (moorings)
11	8x2	R/B	15.100			Fridge
162	14x2	R	15.200			Aft shower drain pump
274	16x2	R/B	8.900		Not by the panel	STBD outside speaker
92	8x1	R	7.200		Not by the panel	Bat.charger to engine battery.
91	8x1	R	7.200		Not by the panel	Bat.charger to house battery
90	8x1	B	7.200		Not by the panel	Negative battery charger
96	8x2	R/B	6.000		Not by the panel	12V Autopilot
961	14x2	R/B	10.900			Autopilot realy
144	14x2	R/B	10.700		Not by the panel	Constant power bilge pump
99	4x2	R/B	10.900			12V Main feed

WIRE #	SIZE AWG	COLOR	L. (m)	Code	NOTE	DESIGNATION
16x2						

R	DESCRIPTION	DATE	DIMENSION:	TOL GEN:	Material:	DATE:	VISA
	FH8 DRAWING		Beneteau 393 Hull harness 3c2t		DATE: 04/16/01		F6
			BENETEAU USA P.O. Drawer 1218 Marion, SC 29571 (803) 423-4201		Part No: 051941		E

R	DESCRIPTION	DATE	DIMENSION:	TOL GEN:	Material:	DATE:	VISA
	FH8 DRAWING		Beneteau 393 Hull Harness - 3C2T		DATE: 04/16/01		F6
			BENETEAU USA P.O. Drawer 1218 Marion, SC 29571 (803) 423-4201		Part No: 051941		E

DECK HARNESS LAYOUT

2 Cabin / 2 Toilet Version

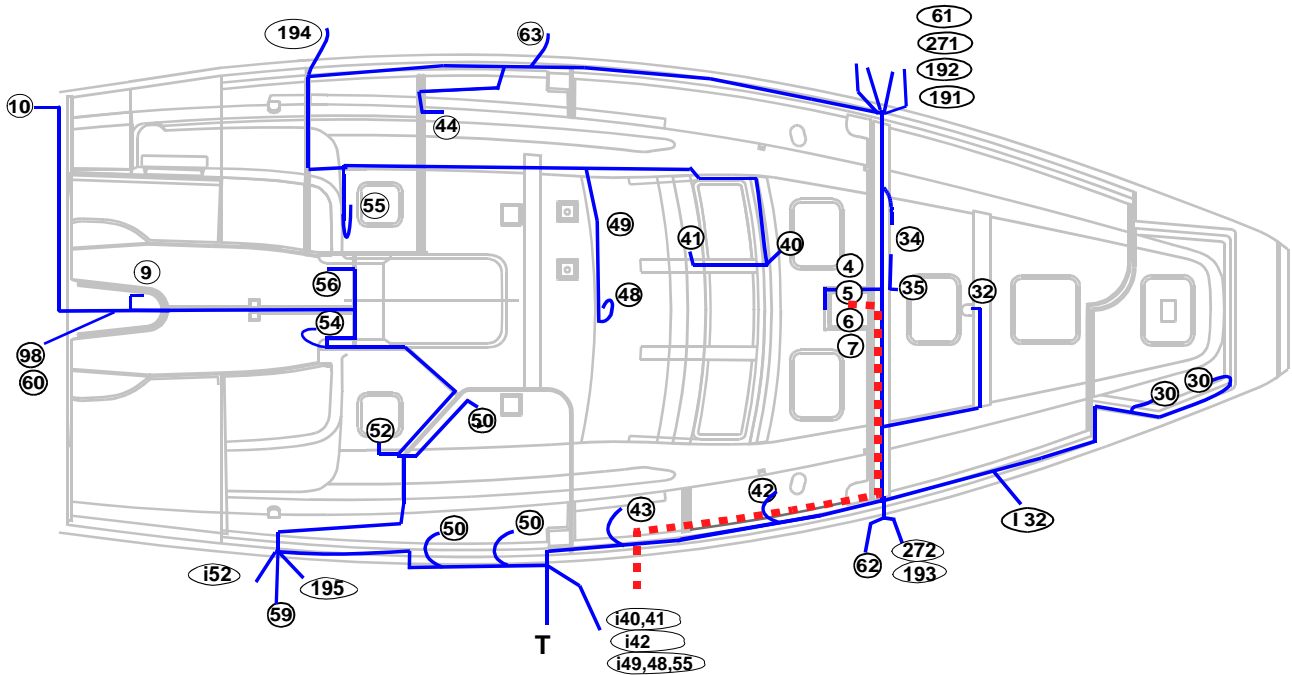

WIRE #	SIZE AWG	COLOR	L. (m)	Code	NOTE	DESIGNATION																																																																																																																																												
196	16x2	R/B	2,020		Picked on 193	Stbd FWD cabin																																																																																																																																												
VHF	coax		6.3			VHF coax panel to mast step																																																																																																																																												
30	16x2	R	8.770		Not by the panel	Fwd toilet light																																																																																																																																												
30		B	8.170		N°30 looped	Fwd toilet light																																																																																																																																												
32	16x2	R	8.990			FWD Cabin ceiling light																																																																																																																																												
63	16x2	R/B	12,450			Port salon Aft reading light																																																																																																																																												
61					N°63 looped	Port salon Fwd reading light																																																																																																																																												
62					N°63 looped	STBD salon Fwd reading light																																																																																																																																												
272	16x2	R/B	4.150		Not by the panel	STBD salon speaker																																																																																																																																												
193	16x2	R/B	4,550			STBD salon fan																																																																																																																																												
42	16x2	R	5,500			STBD salon ceiling light																																																																																																																																												
43	16x2	B	4,100			Chart table light																																																																																																																																												
9	16x2	R/B	12,650			Compass light																																																																																																																																												
98	16x2	R/B	12,650			Instrument power supply tp Helm station																																																																																																																																												
60	16x2	R/B	12,650			Cockpit light																																																																																																																																												
10	16x2	R/B	13,550			Stern light																																																																																																																																												
56	16x2	R/B	10,350			Port aft cabin Stbd reading light																																																																																																																																												
54	16x2	R/B	9,300			STBD Aft cabin port reading light																																																																																																																																												
59	16x2	R/B	5,750		on plug connector	STBDaft cabin aft reading light																																																																																																																																												
52	16x2	R	7,290			STBD aft cabin ceiling fan																																																																																																																																												
52	16x2	B	6,650			STBD aft cabin fan																																																																																																																																												
195	16x2	R/B	4,350			STBD aft cabin fan																																																																																																																																												
53	16x2	R/B	4,350			STBD aft cabin Stbd reading light																																																																																																																																												
50	16x2	R	9,750		Not by the panel	Ceiling STBD aft toilet																																																																																																																																												
50		B	9,150			Ceiling STBD aft toilet																																																																																																																																												
50					N°50 looped	Ceiling STBD aft toilet																																																																																																																																												
50					N°50 looped	Ceiling STBD aft toilet																																																																																																																																												
1	16x2	R/B	1,000		on plug connector	Bow nav light																																																																																																																																												
<table border="1"> <thead> <tr> <th>WIRE #</th> <th>SIZE AWG</th> <th>COLOR</th> <th>L. (m)</th> <th>Code</th> <th>NOTE</th> <th>DESIGNATION</th> </tr> </thead> <tbody> <tr> <td>41</td> <td>16x2</td> <td>R</td> <td>19,300</td> <td></td> <td></td> <td>port salon ceiling light</td> </tr> <tr> <td>41</td> <td>16x2</td> <td>N</td> <td>17,390</td> <td></td> <td></td> <td>port salon ceiling light</td> </tr> <tr> <td>40</td> <td></td> <td></td> <td></td> <td></td> <td>N°41 looped</td> <td>port salon ceiling light</td> </tr> <tr> <td>48</td> <td>16x2</td> <td>R</td> <td>25,800</td> <td></td> <td>Not by the panel</td> <td>Galley ceiling</td> </tr> <tr> <td>48</td> <td>16x2</td> <td>N</td> <td>23,600</td> <td></td> <td></td> <td>Galley ceiling</td> </tr> <tr> <td>49</td> <td></td> <td></td> <td></td> <td></td> <td>N°48 looped</td> <td>Galley ceiling</td> </tr> <tr> <td>55</td> <td></td> <td></td> <td></td> <td></td> <td>N°48 looped</td> <td>Galley fluorescent</td> </tr> <tr> <td>194</td> <td>16x2</td> <td>R/N</td> <td>11,900</td> <td></td> <td></td> <td>Port aft cabin fan</td> </tr> <tr> <td>44</td> <td>16x2</td> <td>R/N</td> <td>10,600</td> <td></td> <td></td> <td>Port aft cabin reading light</td> </tr> <tr> <td>271</td> <td>16x2</td> <td>R/N</td> <td>7,300</td> <td></td> <td>Not by the panel</td> <td>Port speaker</td> </tr> <tr> <td>192</td> <td>16x2</td> <td>R/N</td> <td>7,700</td> <td></td> <td></td> <td>Fwd cabin port fan</td> </tr> <tr> <td>191</td> <td>16x2</td> <td>R/N</td> <td>7,700</td> <td></td> <td></td> <td>Port Salon Fan</td> </tr> <tr> <td>35</td> <td>16x2</td> <td>R</td> <td>8,550</td> <td></td> <td></td> <td>FWD cabin port reading light</td> </tr> <tr> <td>35</td> <td>16x2</td> <td>N</td> <td>5,350</td> <td></td> <td></td> <td>FWD cabin Stbd reading light</td> </tr> <tr> <td>34</td> <td>16x2</td> <td>R</td> <td>7,200</td> <td></td> <td></td> <td>FWD cabin Stbd reading light</td> </tr> <tr> <td>34</td> <td>16x2</td> <td>N</td> <td>6,600</td> <td></td> <td></td> <td>FWD cabin Stbd reading light</td> </tr> <tr> <td>8</td> <td>14x1</td> <td>N</td> <td>5,800</td> <td></td> <td></td> <td>Negative mast</td> </tr> <tr> <td>5,6,7</td> <td>16x3</td> <td>R</td> <td>5,400</td> <td></td> <td></td> <td>Mast light</td> </tr> <tr> <td>4</td> <td>16x1</td> <td>R</td> <td>5,800</td> <td></td> <td></td> <td>Mast tricolor</td> </tr> </tbody> </table>							WIRE #	SIZE AWG	COLOR	L. (m)	Code	NOTE	DESIGNATION	41	16x2	R	19,300			port salon ceiling light	41	16x2	N	17,390			port salon ceiling light	40					N°41 looped	port salon ceiling light	48	16x2	R	25,800		Not by the panel	Galley ceiling	48	16x2	N	23,600			Galley ceiling	49					N°48 looped	Galley ceiling	55					N°48 looped	Galley fluorescent	194	16x2	R/N	11,900			Port aft cabin fan	44	16x2	R/N	10,600			Port aft cabin reading light	271	16x2	R/N	7,300		Not by the panel	Port speaker	192	16x2	R/N	7,700			Fwd cabin port fan	191	16x2	R/N	7,700			Port Salon Fan	35	16x2	R	8,550			FWD cabin port reading light	35	16x2	N	5,350			FWD cabin Stbd reading light	34	16x2	R	7,200			FWD cabin Stbd reading light	34	16x2	N	6,600			FWD cabin Stbd reading light	8	14x1	N	5,800			Negative mast	5,6,7	16x3	R	5,400			Mast light	4	16x1	R	5,800			Mast tricolor
WIRE #	SIZE AWG	COLOR	L. (m)	Code	NOTE	DESIGNATION																																																																																																																																												
41	16x2	R	19,300			port salon ceiling light																																																																																																																																												
41	16x2	N	17,390			port salon ceiling light																																																																																																																																												
40					N°41 looped	port salon ceiling light																																																																																																																																												
48	16x2	R	25,800		Not by the panel	Galley ceiling																																																																																																																																												
48	16x2	N	23,600			Galley ceiling																																																																																																																																												
49					N°48 looped	Galley ceiling																																																																																																																																												
55					N°48 looped	Galley fluorescent																																																																																																																																												
194	16x2	R/N	11,900			Port aft cabin fan																																																																																																																																												
44	16x2	R/N	10,600			Port aft cabin reading light																																																																																																																																												
271	16x2	R/N	7,300		Not by the panel	Port speaker																																																																																																																																												
192	16x2	R/N	7,700			Fwd cabin port fan																																																																																																																																												
191	16x2	R/N	7,700			Port Salon Fan																																																																																																																																												
35	16x2	R	8,550			FWD cabin port reading light																																																																																																																																												
35	16x2	N	5,350			FWD cabin Stbd reading light																																																																																																																																												
34	16x2	R	7,200			FWD cabin Stbd reading light																																																																																																																																												
34	16x2	N	6,600			FWD cabin Stbd reading light																																																																																																																																												
8	14x1	N	5,800			Negative mast																																																																																																																																												
5,6,7	16x3	R	5,400			Mast light																																																																																																																																												
4	16x1	R	5,800			Mast tricolor																																																																																																																																												

WIRE #	SIZE AWG	COLOR	L. (m)	Code	NOTE	DESIGNATION																																																																																																																																																																																																											
41	16x2	R	19,300			port salon ceiling light																																																																																																																																																																																																											
41	16x2	N	17,390			port salon ceiling light																																																																																																																																																																																																											
40					N°41 looped	port salon ceiling light																																																																																																																																																																																																											
48	16x2	R	25,800		Not by the panel	Galley ceiling																																																																																																																																																																																																											
48	16x2	N	23,600			Galley ceiling																																																																																																																																																																																																											
49					N°48 looped	Galley ceiling																																																																																																																																																																																																											
55					N°48 looped	Galley fluorescent																																																																																																																																																																																																											
194	16x2	R/N	11,900			Port aft cabin fan																																																																																																																																																																																																											
44	16x2	R/N	10,600			Port aft cabin reading light																																																																																																																																																																																																											
271	16x2	R/N	7,300		Not by the panel	Port speaker																																																																																																																																																																																																											
192	16x2	R/N	7,700			Fwd cabin port fan																																																																																																																																																																																																											
191	16x2	R/N	7,700			Port Salon Fan																																																																																																																																																																																																											
35	16x2	R	8,550			FWD cabin port reading light																																																																																																																																																																																																											
35	16x2	N	5,350			FWD cabin Stbd reading light																																																																																																																																																																																																											
34	16x2	R	7,200			FWD cabin Stbd reading light																																																																																																																																																																																																											
34	16x2	N	6,600			FWD cabin Stbd reading light																																																																																																																																																																																																											
8	14x1	N	5,800			Negative mast																																																																																																																																																																																																											
5,6,7	16x3	R	5,400			Mast light																																																																																																																																																																																																											
4	16x1	R	5,800			Mast tricolor																																																																																																																																																																																																											
<table border="1"> <thead> <tr> <th>WIRE #</th> <th>SIZE AWG</th> <th>COLOR</th> <th>L. (m)</th> <th>Code</th> <th>NOTE</th> <th>DESIGNATION</th> </tr> </thead> <tbody> <tr> <td>196</td> <td>16x2</td> <td>R/B</td> <td>2,020</td> <td></td> <td>Picked on 193</td> <td>Stbd FWD cabin</td> </tr> <tr> <td>VHF</td> <td>coax</td> <td></td> <td>6.3</td> <td></td> <td></td> <td>VHF coax panel to mast step</td> </tr> <tr> <td>30</td> <td>16x2</td> <td>R</td> <td>8.770</td> <td></td> <td>Not by the panel</td> <td>Fwd toilet light</td> </tr> <tr> <td>30</td> <td></td> <td>B</td> <td>8.170</td> <td></td> <td>N°30 looped</td> <td>Fwd toilet light</td> </tr> <tr> <td>32</td> <td>16x2</td> <td>R</td> <td>8.990</td> <td></td> <td></td> <td>FWD Cabin ceiling light</td> </tr> <tr> <td>63</td> <td>16x2</td> <td>R/B</td> <td>12,450</td> <td></td> <td></td> <td>Port salon Aft reading light</td> </tr> <tr> <td>61</td> <td></td> <td></td> <td></td> <td></td> <td>N°63 looped</td> <td>Port salon Fwd reading light</td> </tr> <tr> <td>62</td> <td></td> <td></td> <td></td> <td></td> <td>N°63 looped</td> <td>STBD salon Fwd reading light</td> </tr> <tr> <td>272</td> <td>16x2</td> <td>R/B</td> <td>4.150</td> <td></td> <td>Not by the panel</td> <td>STBD salon speaker</td> </tr> <tr> <td>193</td> <td>16x2</td> <td>R/B</td> <td>4,550</td> <td></td> <td></td> <td>STBD salon fan</td> </tr> <tr> <td>42</td> <td>16x2</td> <td>R</td> <td>5,500</td> <td></td> <td></td> <td>STBD salon ceiling light</td> </tr> <tr> <td>43</td> <td>16x2</td> <td>B</td> <td>4,100</td> <td></td> <td></td> <td>Chart table light</td> </tr> <tr> <td>9</td> <td>16x2</td> <td>R/B</td> <td>12,650</td> <td></td> <td></td> <td>Compass light</td> </tr> <tr> <td>98</td> <td>16x2</td> <td>R/B</td> <td>12,650</td> <td></td> <td></td> <td>Instrument power supply tp Helm station</td> </tr> <tr> <td>60</td> <td>16x2</td> <td>R/B</td> <td>12,650</td> <td></td> <td></td> <td>Cockpit light</td> </tr> <tr> <td>10</td> <td>16x2</td> <td>R/B</td> <td>13,550</td> <td></td> <td></td> <td>Stern light</td> </tr> <tr> <td>56</td> <td>16x2</td> <td>R/B</td> <td>10,350</td> <td></td> <td></td> <td>Port aft cabin Stbd reading light</td> </tr> <tr> <td>54</td> <td>16x2</td> <td>R/B</td> <td>9,300</td> <td></td> <td></td> <td>STBD Aft cabin port reading light</td> </tr> <tr> <td>59</td> <td>16x2</td> <td>R/B</td> <td>5,750</td> <td></td> <td>on plug connector</td> <td>STBDaft cabin aft reading light</td> </tr> <tr> <td>52</td> <td>16x2</td> <td>R</td> <td>7,290</td> <td></td> <td></td> <td>STBD aft cabin ceiling fan</td> </tr> <tr> <td>52</td> <td>16x2</td> <td>B</td> <td>6,650</td> <td></td> <td></td> <td>STBD aft cabin fan</td> </tr> <tr> <td>195</td> <td>16x2</td> <td>R/B</td> <td>4,350</td> <td></td> <td></td> <td>STBD aft cabin fan</td> </tr> <tr> <td>53</td> <td>16x2</td> <td>R/B</td> <td>4,350</td> <td></td> <td></td> <td>STBD aft cabin Stbd reading light</td> </tr> <tr> <td>50</td> <td>16x2</td> <td>R</td> <td>9,750</td> <td></td> <td>Not by the panel</td> <td>Ceiling STBD aft toilet</td> </tr> <tr> <td>50</td> <td></td> <td>B</td> <td>9,150</td> <td></td> <td></td> <td>Ceiling STBD aft toilet</td> </tr> <tr> <td>50</td> <td></td> <td></td> <td></td> <td></td> <td>N°50 looped</td> <td>Ceiling STBD aft toilet</td> </tr> <tr> <td>50</td> <td></td> <td></td> <td></td> <td></td> <td>N°50 looped</td> <td>Ceiling STBD aft toilet</td> </tr> <tr> <td>1</td> <td>16x2</td> <td>R/B</td> <td>1,000</td> <td></td> <td>on plug connector</td> <td>Bow nav light</td> </tr> </tbody> </table>							WIRE #	SIZE AWG	COLOR	L. (m)	Code	NOTE	DESIGNATION	196	16x2	R/B	2,020		Picked on 193	Stbd FWD cabin	VHF	coax		6.3			VHF coax panel to mast step	30	16x2	R	8.770		Not by the panel	Fwd toilet light	30		B	8.170		N°30 looped	Fwd toilet light	32	16x2	R	8.990			FWD Cabin ceiling light	63	16x2	R/B	12,450			Port salon Aft reading light	61					N°63 looped	Port salon Fwd reading light	62					N°63 looped	STBD salon Fwd reading light	272	16x2	R/B	4.150		Not by the panel	STBD salon speaker	193	16x2	R/B	4,550			STBD salon fan	42	16x2	R	5,500			STBD salon ceiling light	43	16x2	B	4,100			Chart table light	9	16x2	R/B	12,650			Compass light	98	16x2	R/B	12,650			Instrument power supply tp Helm station	60	16x2	R/B	12,650			Cockpit light	10	16x2	R/B	13,550			Stern light	56	16x2	R/B	10,350			Port aft cabin Stbd reading light	54	16x2	R/B	9,300			STBD Aft cabin port reading light	59	16x2	R/B	5,750		on plug connector	STBDaft cabin aft reading light	52	16x2	R	7,290			STBD aft cabin ceiling fan	52	16x2	B	6,650			STBD aft cabin fan	195	16x2	R/B	4,350			STBD aft cabin fan	53	16x2	R/B	4,350			STBD aft cabin Stbd reading light	50	16x2	R	9,750		Not by the panel	Ceiling STBD aft toilet	50		B	9,150			Ceiling STBD aft toilet	50					N°50 looped	Ceiling STBD aft toilet	50					N°50 looped	Ceiling STBD aft toilet	1	16x2	R/B	1,000		on plug connector	Bow nav light
WIRE #	SIZE AWG	COLOR	L. (m)	Code	NOTE	DESIGNATION																																																																																																																																																																																																											
196	16x2	R/B	2,020		Picked on 193	Stbd FWD cabin																																																																																																																																																																																																											
VHF	coax		6.3			VHF coax panel to mast step																																																																																																																																																																																																											
30	16x2	R	8.770		Not by the panel	Fwd toilet light																																																																																																																																																																																																											
30		B	8.170		N°30 looped	Fwd toilet light																																																																																																																																																																																																											
32	16x2	R	8.990			FWD Cabin ceiling light																																																																																																																																																																																																											
63	16x2	R/B	12,450			Port salon Aft reading light																																																																																																																																																																																																											
61					N°63 looped	Port salon Fwd reading light																																																																																																																																																																																																											
62					N°63 looped	STBD salon Fwd reading light																																																																																																																																																																																																											
272	16x2	R/B	4.150		Not by the panel	STBD salon speaker																																																																																																																																																																																																											
193	16x2	R/B	4,550			STBD salon fan																																																																																																																																																																																																											
42	16x2	R	5,500			STBD salon ceiling light																																																																																																																																																																																																											
43	16x2	B	4,100			Chart table light																																																																																																																																																																																																											
9	16x2	R/B	12,650			Compass light																																																																																																																																																																																																											
98	16x2	R/B	12,650			Instrument power supply tp Helm station																																																																																																																																																																																																											
60	16x2	R/B	12,650			Cockpit light																																																																																																																																																																																																											
10	16x2	R/B	13,550			Stern light																																																																																																																																																																																																											
56	16x2	R/B	10,350			Port aft cabin Stbd reading light																																																																																																																																																																																																											
54	16x2	R/B	9,300			STBD Aft cabin port reading light																																																																																																																																																																																																											
59	16x2	R/B	5,750		on plug connector	STBDaft cabin aft reading light																																																																																																																																																																																																											
52	16x2	R	7,290			STBD aft cabin ceiling fan																																																																																																																																																																																																											
52	16x2	B	6,650			STBD aft cabin fan																																																																																																																																																																																																											
195	16x2	R/B	4,350			STBD aft cabin fan																																																																																																																																																																																																											
53	16x2	R/B	4,350			STBD aft cabin Stbd reading light																																																																																																																																																																																																											
50	16x2	R	9,750		Not by the panel	Ceiling STBD aft toilet																																																																																																																																																																																																											
50		B	9,150			Ceiling STBD aft toilet																																																																																																																																																																																																											
50					N°50 looped	Ceiling STBD aft toilet																																																																																																																																																																																																											
50					N°50 looped	Ceiling STBD aft toilet																																																																																																																																																																																																											
1	16x2	R/B	1,000		on plug connector	Bow nav light																																																																																																																																																																																																											

3 Cabin / 2 Toilet Version

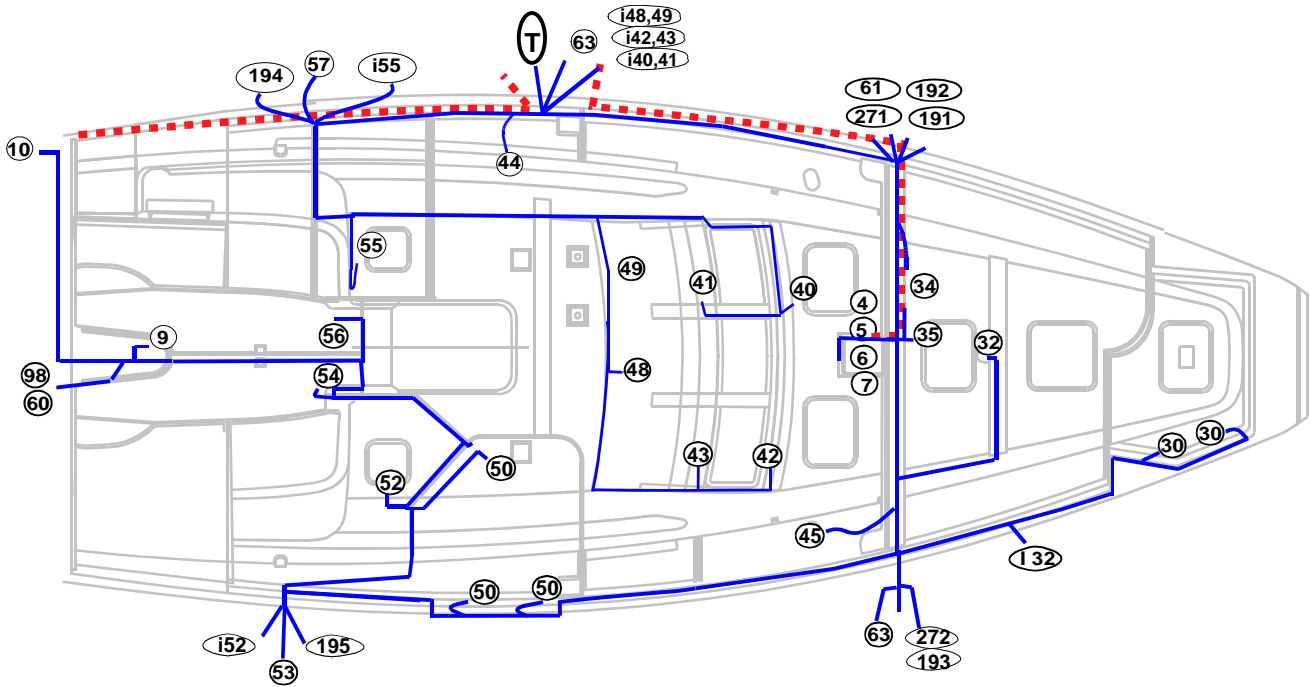

WIRE #	SIZE AWG	COLOR	L. (m)	Code	NOTE	DESIGNATION
VHF	coax		6,500			VHF coax
272	16X2	R/B	7,800		Not by the panel	STBD salon speaker
193	16X2	R/B	7,800			STBD salon fan
45	16X2	R/B	8,000			Galley ceiling
32	16X2	R 12,240 B 8,400			Caution switch	FWD cabin ceiling
8	14X1	B	6,200			Negative mast
5,6,7	16X3	R	5,800			Mast lights
4	16X1	R	6,200			Tricolor mast light
35	16X2	R 6,800 B 6,200				STBD reading light FWD cabin
34	16X2	R 6,150 B 5,550				Port reading light Fwd cabin
192	16X2	R/B	4,650			Port salon fan
191	16X2	R/B	4,650			FWD cabin fan
271	16X2	R/B	4,650		Not by the panel	Port salon speaker
41	16X2	R 12,150 B 10,150			Not by the panel	Port salon ceiling light
40					N°41 looped	Port salon ceiling light
48	16X2	R 12,850 B 10,850				Aft salon ceiling light
49					N°48 looped	Chart table ceiling light
55	16X2	R 8,150 B 6,950				Port aft cabin ceiling light
57	16X2	R/B	4,250			Fwd reading light port aft cabin
194	16X2	R/B	4,150			Port aft cabin fan
63	16X2	R/B	10,400			Aft reading light port salon
61					N°63 looped	Fwd reading light port salon
62					N°63 looped	Fwd reading light STBD salon
44	16X2	R/B	2,850			Red nav light chart table
WIRE #	SIZE AWG	COLOR	L. (m)	Code	NOTE	DESIGNATION

WIRE #	SIZE AWG	COLOR	L. (m)	Code	NOTE	DESIGNATION
9	16x2	R/B	20,200			Compass light
60	16x2	R/B	20,200			Cockpit light
98	16x2	R/B	20,200			Instrument power supply to helm station
10	16x2	R/B	21,300			Stern light
56	16x2	R/B	18,100			Stbd reading light port aft cabin
54	16x2	R/B	17,050			Port reading light aft Stbd cabin
53	16x2	R/B	12,100			Stbd reading light aft STBD
195	16x2	R/B	12,100			Fan aft STBD cabin
52	16x2	R 15,000 B 14,400				Ceiling light Aft STBD cabin
50	16x2	R 17,300 B 16,700			Not by the panel	STBD aft toilet lights
50					N°50 looped	STBD aft toilet lights
50					N°50 looped	STBD aft toilet lights
43	16x2	R 14,95 B 12,950				Aft ceiling STBD salon
42					N°43 looped	Fwd ceiling STBD salon
30	16x2	R 12,020 B 11,420			Not by the panel	Fwd toilet lights
WIRE #	SIZE AWG	COLOR	L. (m)	Code	NOTE	DESIGNATION

THIS DOCUMENT IS PROPRIETARY AND REPRODUCTIONS MUST BE AUTHORIZED BY BENETEAU DRAWN BY BENETEAU - SPECIFIED AND DESIGNED BY PRODUCT MANUFACTURER.

THIS DOCUMENT IS PROPRIETARY AND REPRODUCTIONS MUST BE AUTHORIZED BY BENETEAU DRAWN BY BENETEAU - SPECIFIED AND DESIGNED BY PRODUCT MANUFACTURER.

LAY OUT OF THE CONDUITS

Conduits in deck



Conduits in hull



2 Cabin / 2 Toilet

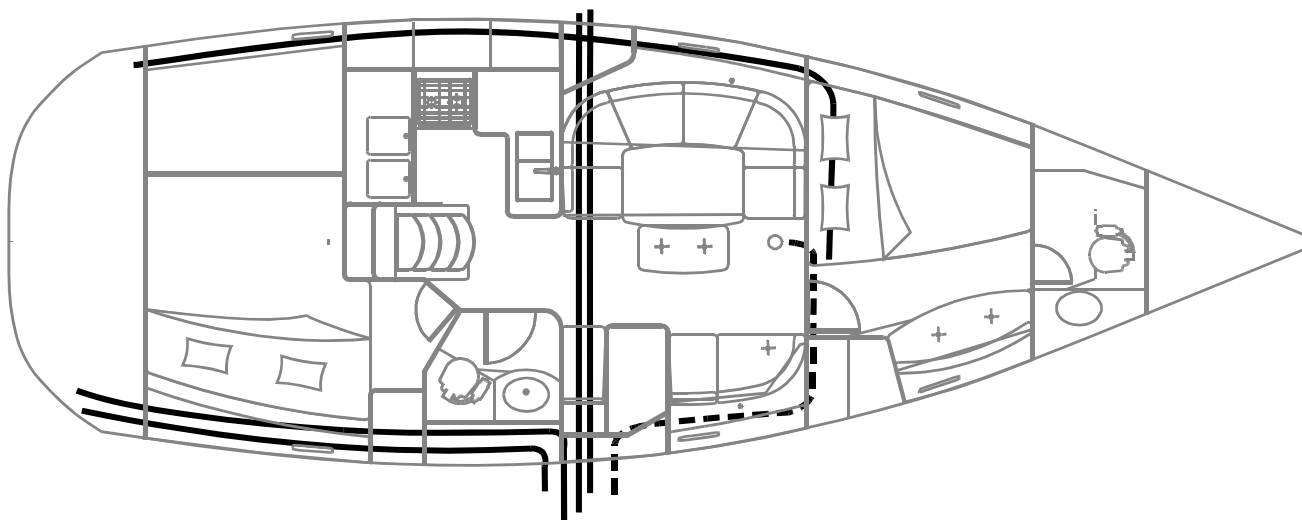

3 Cabin / 2 Toilet

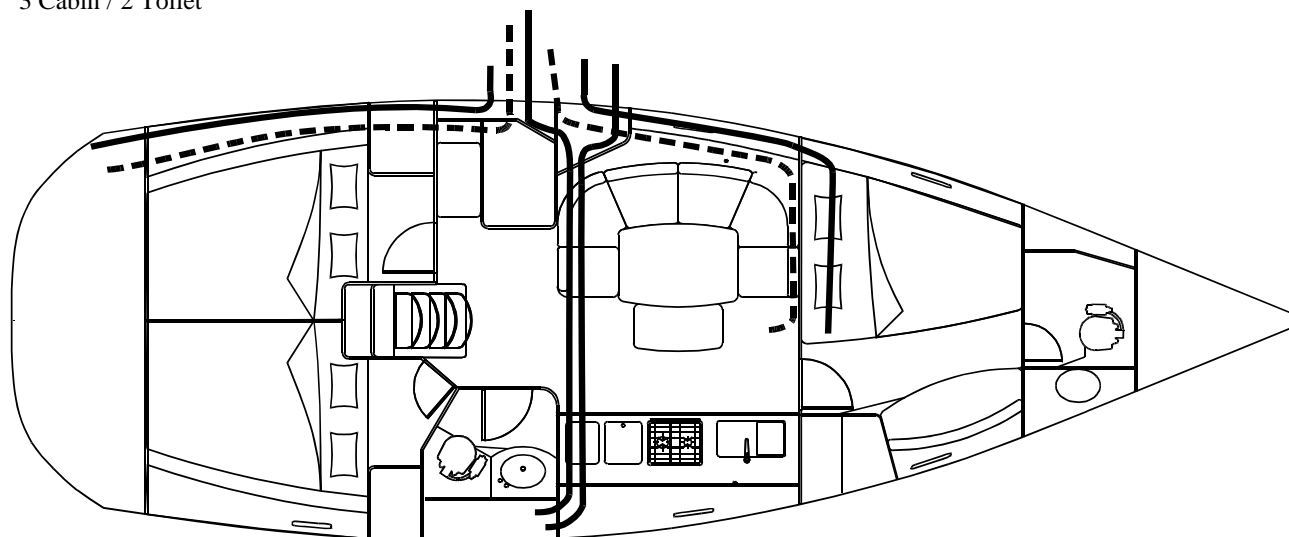

XVIII) LP GAS SYSTEM

Gas Stove

The boat is delivered without a fire extinguisher. It is your responsibility to comply with the laws and regulations of your country (Number, capacity, type and place of fire extinguishers). We advise you to install an extinguisher less than 5 meters away from the center of each berth, less than 2 meters away from the extinguisher aperture in the engine compartment, less than 2 meters away from any open flame device and less than 1 meter away from the helm pedestal or cockpit. We advise a total capacity of the portable extinguishers reaching 8A/64B, each extinguisher having at least a 5A/34B capacity. The CO2 extinguishers shall be used to fight fires in the galley and electric fires.

Do not install or store flammable materials above the stove (Curtains, papers, napkins, etc...)

Never leave the boat unattended when the LP gas appliances are in use.

The appliances, which use fuel, consume the oxygen within the cabin and release combustion products into the boat. It is necessary to ventilate the boat when using the gas cooking appliances. Do not obstruct the air vents of the boat.

Do not smoke or use an open flame when you are trying to locate a gas leak, change the gas bottle or work on the gas system.

If you smell gas or find that the burners have gone out by accident, (although appliance models cut off the gas automatically if the flames go out) turn off the gas valves and ventilate the boat in order to get rid of any residual gas. Find the cause of the problem before re-lighting the appliance.

Do not use cooking appliances to heat the inside of the boat.

Make sure that the burner valves are turned off before you turn on the 12V solenoid and the valve on the cylinder.

Turn off the 12V solenoid and the valve on the cylinder when you do not use the appliances.

Do not obstruct the access to the gas system components, in particular the access to the valves (cylinders and gas cooker).

The flexible hoses, which connect the gas cylinder at one end of the system and the stove at the other end, shall be changed in pursuance of the regulations in force in your country. Only use hoses, which meet the safety standards of your country.

Do not use the gas cylinder storage space to store other equipment.

Pay particular attention to keep in good condition the screw thread of the cylinder on which the regulator is attached. Check the condition of the regulator every year and change it if necessary. Use a regulator identical to the one which is fitted.

Make sure that the valve of the empty cylinder is turned off and disconnected from the system.

Do not use ammonia-based products to clean any part of the system or to discover a leak.

The LP gas system should be checked for leaks on a regular basis. See the manual provided with the stove for instructions.

LAY OUT OF THE GAS SYSTEM

REF	DESCRIPTION
1	Gas Locker
2	Valve and Regulator
3	Gas Locker Ventilation

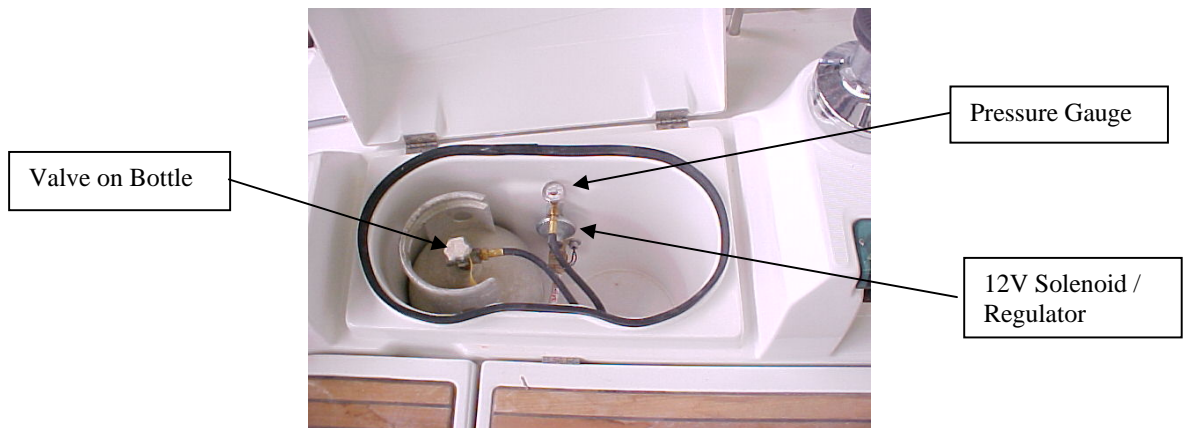
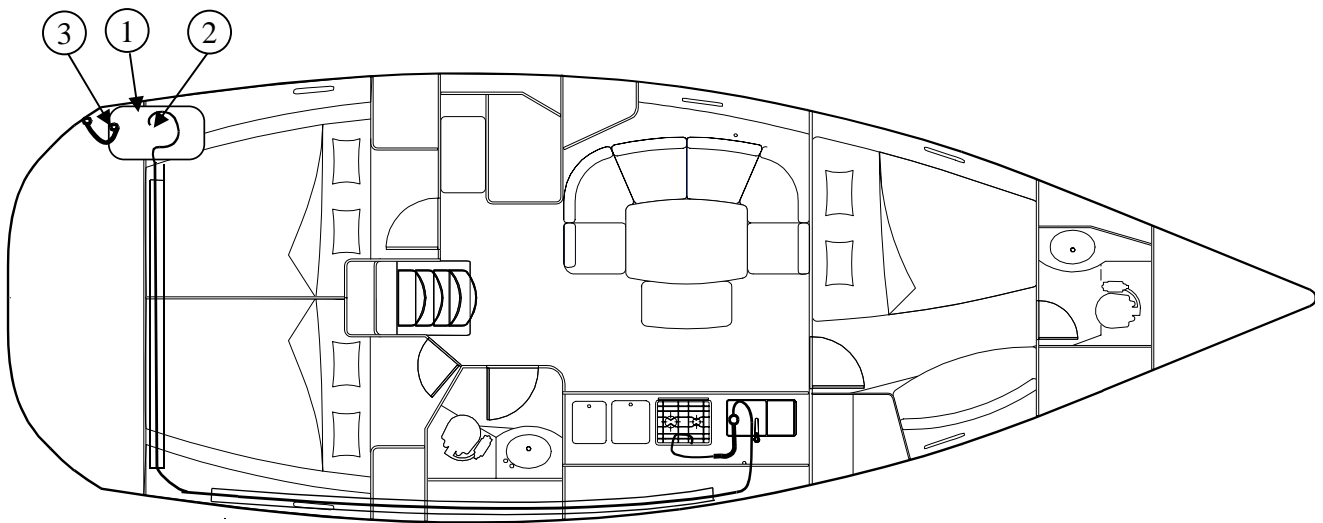
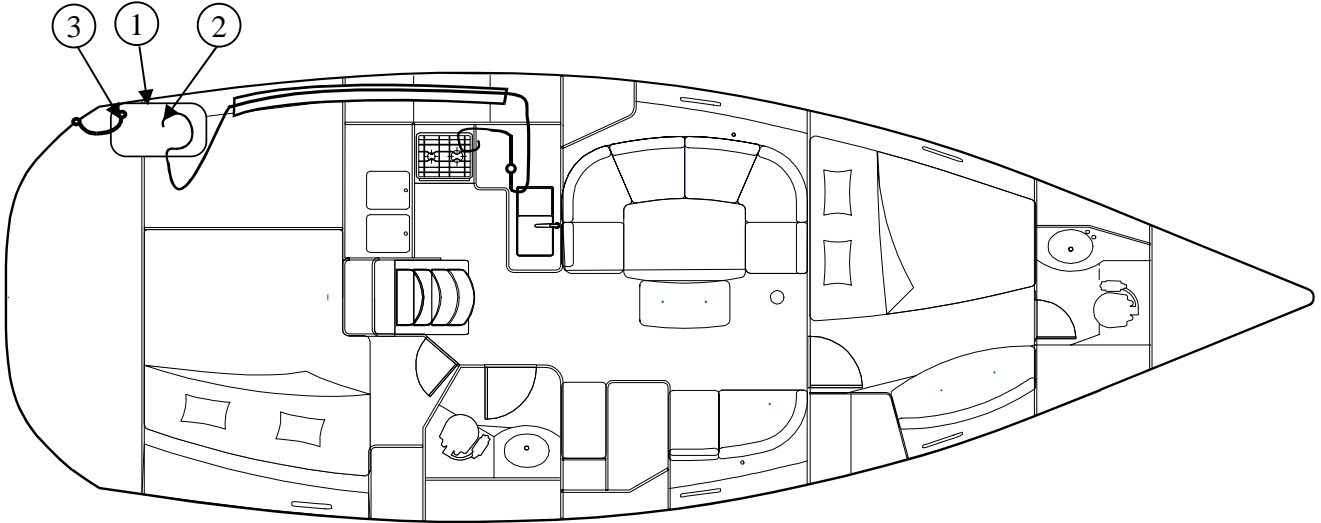

XIX) EMERGENCY STEERING SYSTEM

Your boat is provided with an emergency tiller for use if there is a failure in the wheel steering system.

Check at least once a year that the steering cables are properly tightened and lubricated.

To use the emergency tiller, remove the cover over the rudder stock by using a winch handle; insert the tiller into the socket on the rudderstock. You may remove the steering wheel while using the tiller, to improve the tiller handle clearance.

REF	DESCRIPTION
1	Emergency Tiller
2	Cap Over Rudder Stock
3	Rudder Stock
4	Steering Cable
5	Quadrant
6	Upper Rudder Shaft Bearing
7	Split Sleeve
8	Compensation Washer

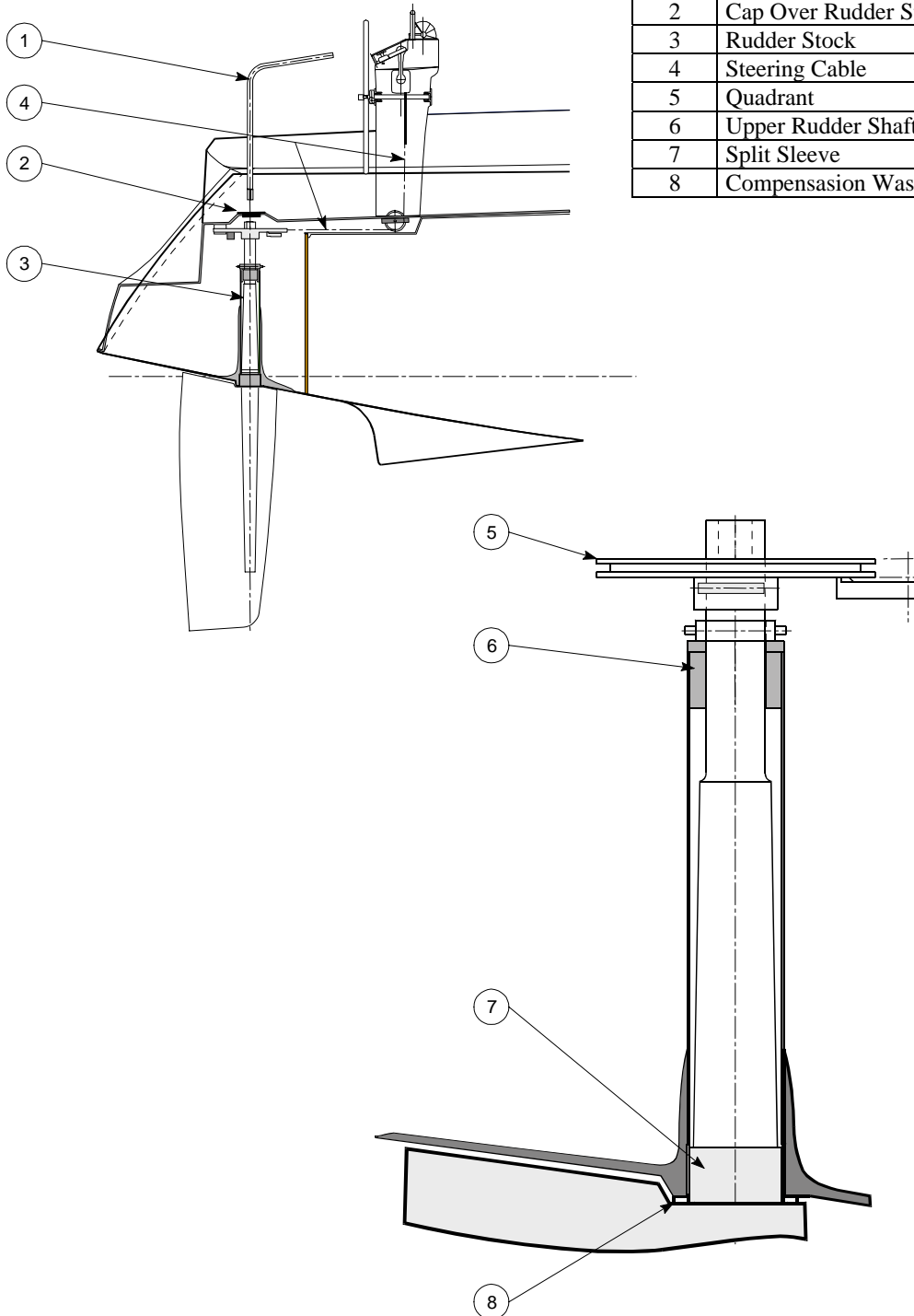

XX) ENGINE

STARTING THE ENGINE

Insert the ignition key and turn it to "ON" (and then to the intermediate preheat position if your boat's engine has this system). A warning alarm will sound as you start up - the engine manual explains the meaning of this alarm and its operation. Press the starter button or turn the key, as appropriate, and release the button or key, as soon as the engine is running.

CHECK THE ENGINE EXHAUST FOR COOLING WATER DISCHARGE, IMMEDIATELY STOP THE ENGINE AND CHECK THE RAW WATER SYSTEM. IF NO COOLING WATER IS DISCHARGED FROM THE EXHAUST.

Let the engine run for a moment, and then bring the throttle lever back to the idle position. After you engage the clutch, increase the engine speed very gradually (it should take at least five minutes to reach cruising speed), because a diesel engine will warm up only when it is under load.

Do not operate the starter for more than 10 seconds at a time. If the engine does not start, wait at least 30 seconds before trying again.

CAUTION! OVERCRANKING ENGINE WITH WATER LIFT MUFFLER CAN CAUSE DAMAGE! IF THE ENGINE DOES NOT START-CLOSE THRU HULL AND SEEK ASSISTANCE.

Once engine has started, check that the warning lights for oil and coolant pressure have gone out, and that the batteries are charging properly.

Check that the coolant water is circulating correctly, water should be either venting through the exhaust or passing through the heat-exchanger return circuit, depending on the cooling system fitted.

CAUTION! NEVER OPERATE THE BATTERY CIRCUIT SWITCH OR THE IGNITION KEY WHEN THE ENGINE IS RUNNING. THE RESULTING CURRENT SURGE WILL DAMAGE THE ALTERNATOR DIODES.

Engage the clutch firmly but not harshly. Do not rev the engine hard. When shifting from forward to reverse, or vice versa, the lever should be held in the neutral position for a moment before proceeding. Shifting should be performed with RPM reduced to idle. Keep a regular watch to make sure that the coolant water is circulating properly.

STOPPING THE ENGINE

To stop the engine:

1. Place throttle/transmission lever in the idle/neutral position.
2. Let engine idle for one (1) minute to allow it to cool down.
3. Engage the engine kill button until the engine stops.
4. Turn the key to the "OFF" position.

CAUTION! DO NOT SWITCH BATTERY SELECTOR UNTIL THE ENGINE HAS COME TO A COMPLETE STOP! THIS WILL PREVENT ALTERNATOR DIODE DAMAGE.

CAUTION! IF YOU CLOSE THE FUEL AND SEA WATER VALVES AFTER STOPPING THE ENGINE, BE SURE TO RE-OPEN THEM BEFORE RESTARTING. FAILURE TO DO SO COULD CAUSE ENGINE TO OVER-HEAT AND CAUSE DAMAGE TO THE PUMP IMPELLER OR CAUSE FUEL LINES TO BECOME AIR LOCKED.

Stop the engine; and do not smoke while you are filling up the fuel tank.

Before you start the engine, make sure that the engine compartment bilge is clean and dry. If there is the slightest presence of fuel in the engine compartment, you must not start the engine.

Fuel that is stored outside the tanks (spare cans, jerrycans) should be kept and stored in a ventilated place.

Know exactly where the fire extinguisher aperture is located so you will be able to put out a fire breaking out in the engine compartment.

REF	DESCRIPTION	REF	DESCRIPTION
1	Engine Ventilation Cowl	16	Propeller
2	Engine Ventilation Hose	17	Exhaust Hose
3	Anti- Siphon Valve	18	Hatch to the Engine
4	Companionway Stair	19	Battery Switches
5	Fire Extinguisher aperture	20	Intake Strainer
6	House Battery	21	Engine Panel (at port helm station)
7	Engine	22	Skeg
8	Coupling Plate	23	Exhaust Outlet
9	Muffler	24	Sea Water Filter
10	Engine Water Intake	25	Fuel Filter
11	Engine Control Handle in the Cockpit	26	Engine Stop Control (on engine panel)
12	Shaft Seal	27	Fuel Shutoff Control
13	Propeller Shaft	28	Fuel – Deck Fill
14	Fuel Tank	29	Stern Tube Valve
15	Stern Tube	30	Engine Battery

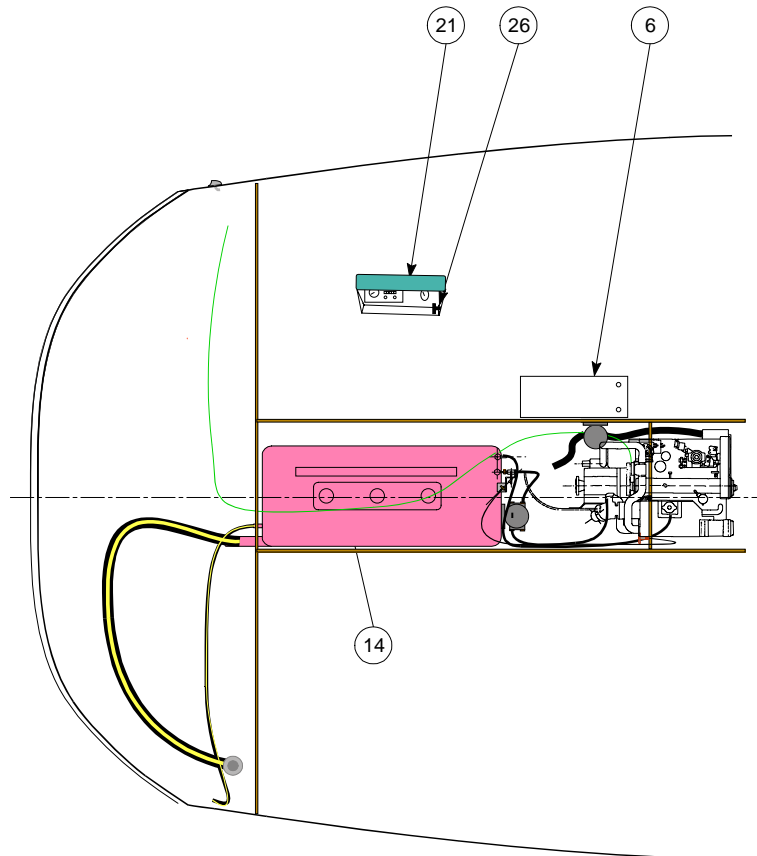

ENGINE LAY OUT

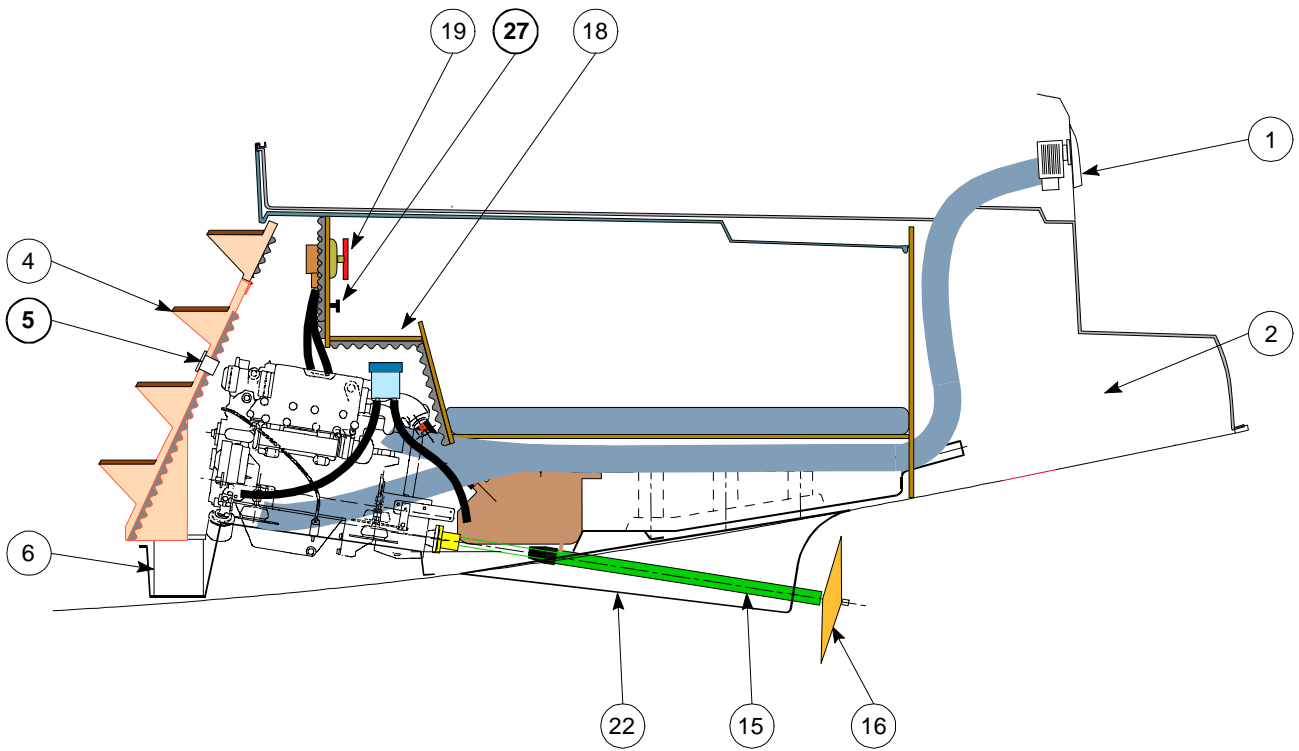
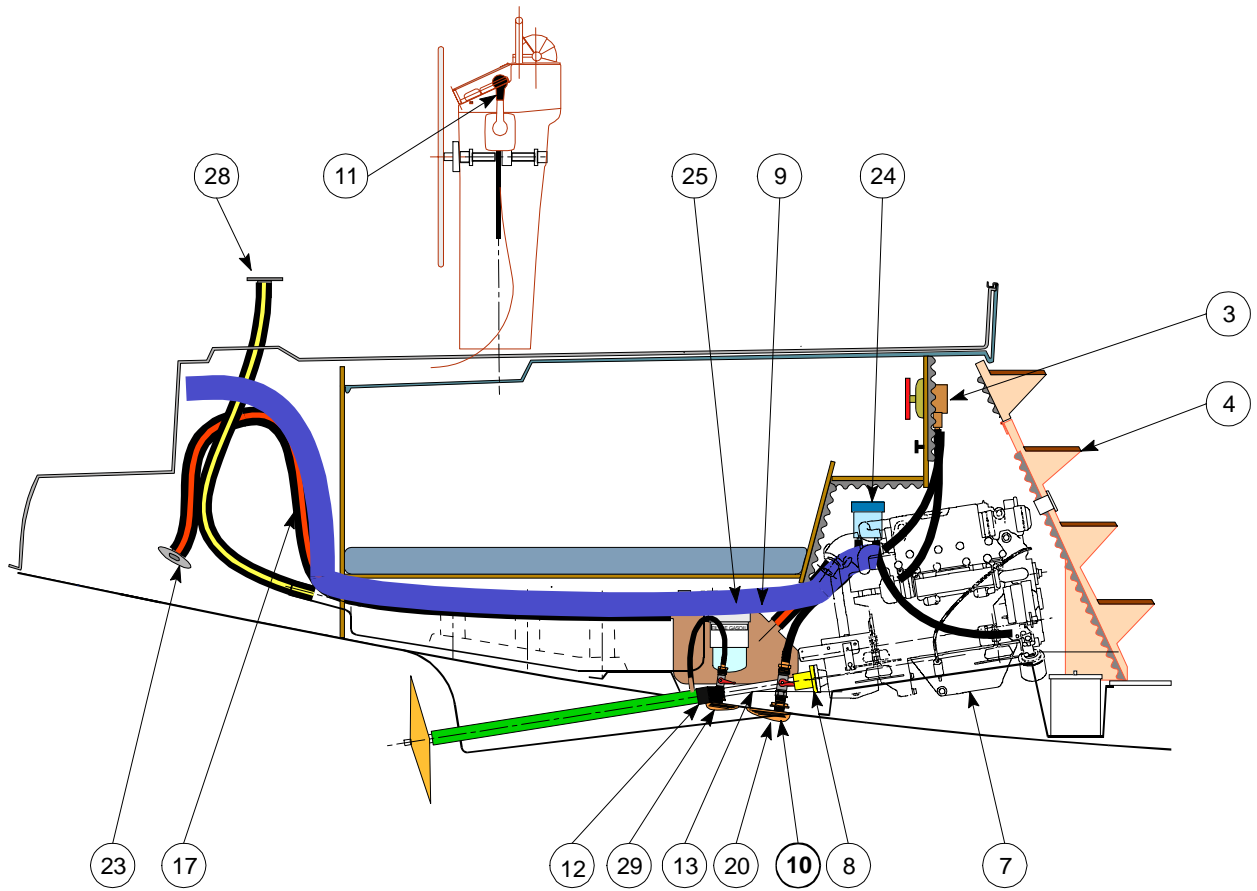

XXI) HANDLING

Contact your BENETEAU dealer for maintenance and repair of your boat. The dealer will advise properly, or will supply you with the spare parts you need or the materials that are suited to your boat.

Have your boat hauled & serviced once a year.

POSITION OF LIFTING STRAPS AND CRADLE POSITION.

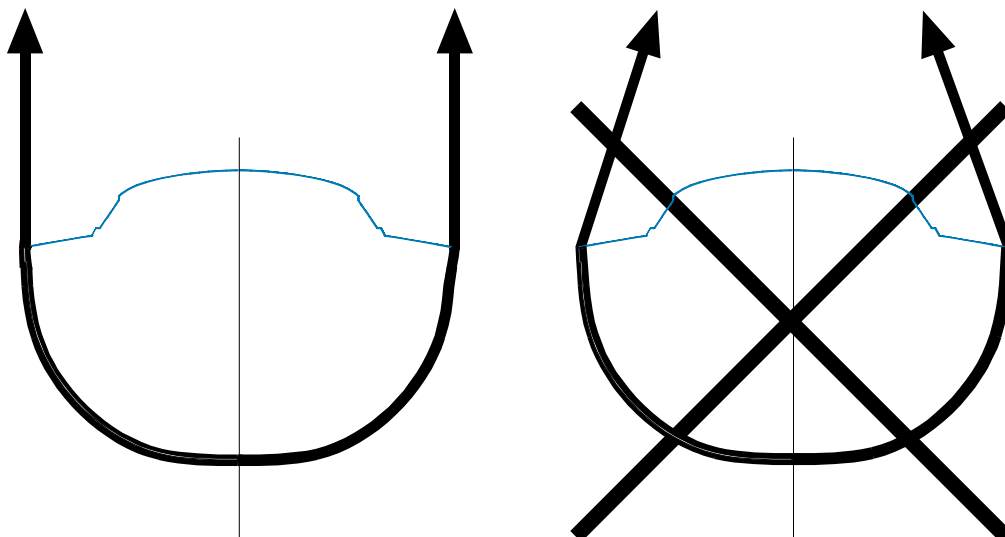
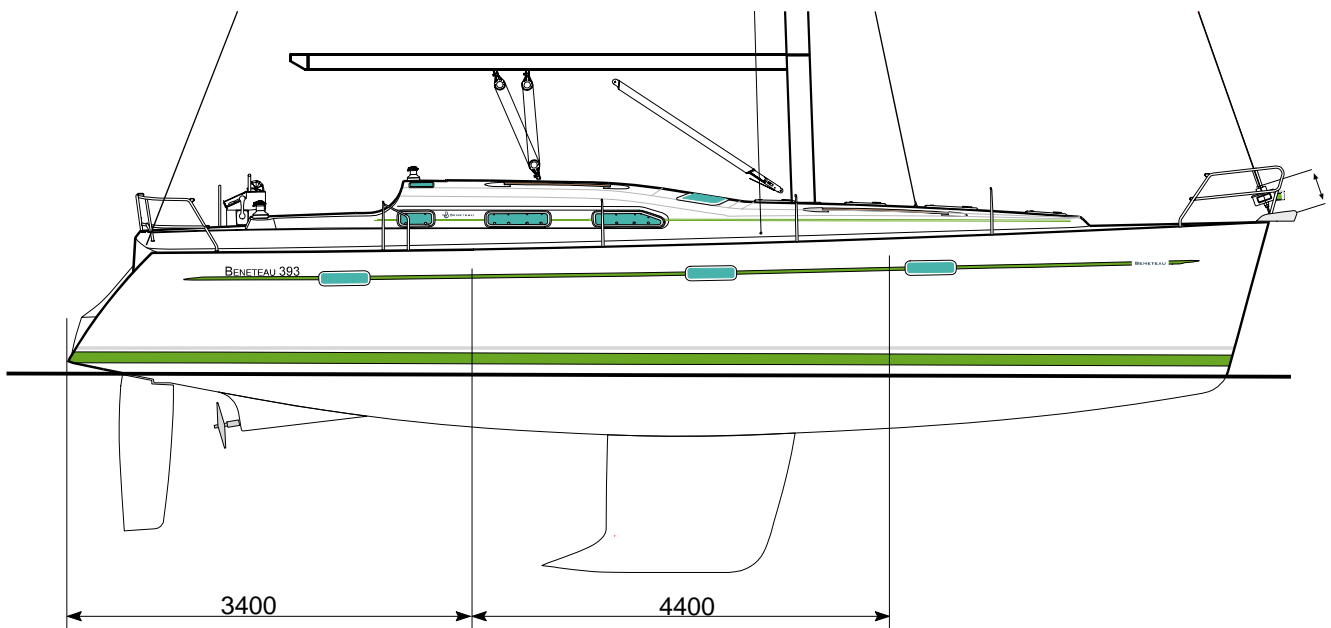

XXII) MAINTENANCE OF YOUR BOAT

Your boat represents a sizable capital investment that needs special and regular care. Safeguarding your investment and looking after your own safety should persuade you of the importance of careful and regular upkeep of your boat. The maintenance suggestions in the following sections will help you with the basics. Always refer to the original manufacturer's manual for specific guidelines on individual components.

NOTE: It is important to clean the bottom of your boat at least two or three times a year.

General Hull Maintenance

- **DO NOT SAND THE HULL WITH COARSE SANDPAPER.**
- **DO NOT USE SOLVENTS TO CLEAN HULL.**
- **DO NOT WASH WITH PRESSURE MACHINE USING WATER WARMER THAN 70 DEGREES F. (21 degrees C.).**
- **DO NOT USE PRESSURE EXCESS OF 2175 PSI (150 BAR.) WHEN USING A HIGH PRESSURE SPRAY WASH.**
- **DO NOT HOLD NOZZLE CLOSER THAN 4 INCHES (10 CM) TO SURFACE OF HULL.**
- **DO NOT MACHINE SAND.**

We believe the above points to be pertinent for all FRP boats.

GEL COAT

The gel-coat is vulnerable to any dents and scratches it may get during maneuvering in harbor and on a mooring. The best way to avoid them is to undertake maneuvering calmly, after thinking out all the relevant factors (such as speed, current, wind, and the layout of the harbor). Always have one of the crew ready to put out a fender at the right place. When bringing in the anchor chain, back off or swing the boat round so as not to rub the chain against the hull. Hold the anchor well clear as you bring it aboard so that it does not scrape the stem: lay it on deck and lash it down at once, if only temporarily.

Never use dirty fenders.

Hose off the hull and deck as often as possible, with fresh water.

Before hosing down, remember to check that the hatch covers are closed; and it is wise not to take on diesel oil or fresh water supplies while you are hosing off the hull.

After a few years, the gel coat may be re-polished, either with a lambs wool buffer and polish, or by hand using a polish or similar product. Your yard will also be able to supply you with special cleaning products for getting rid of stubborn stains.

MINOR GEL COAT REPAIRS

To fill in a scratch or small dent, order a **Beneteau Gel coat Repair Kit** with instructions for use, from your dealer or obtain a small quantity of gel coat and catalyst.

Clean the affected area and rub it down with wet-and-dry sandpaper, then dry it off thoroughly (use a hair-dryer if necessary). Mix the components of the gel coat, and fill the scratch using a spatula avoiding any excess; cover with a sheet of cellophane. Once hardened remove cellophane and rub down with very fine wet/dry sandpaper (grade 600 or 800), and finish off by polishing the new surface.

THE DECK AND DECK FITTINGS

Using a gentle liquid detergent, scrub all nonskid areas to keep them free of dirt.

Light-alloy sections (tracks, etc.) can be cleaned in the same manner.

The tiny spots of oxidation pitting that may appear on stainless steel parts are nothing to worry about. Polishing will remove them.

From time to time, lubricate pulley blocks and sheaves, turnbuckles, tracks and travelers with light grease or a water-repellent lubricant such as WD-40 or Triflow.

After a certain time at sea, your winches will need cleaning inside. They must be cleaned out completely once a year. Follow the manufacturer's instructions carefully.

When dismantling deck fittings, have a bowl close at hand for putting the parts in, and circle the area with a rolled dishcloth, or the like, so that any screws or springs you drop do not roll overboard. Use the lubricant recommended by the manufacturer before reassembling.

Warning! Incorrect re-assembly can cause accidents. Note the order in which parts are dismantled, which will make it easier to put them together again later.

Acrylic plastic hatch covers and portholes should be rinsed off with fresh water and rubbed over with a soft cloth soaked in liquid paraffin.

THE RUDDER

Once a year, check steering gear. If necessary renew any parts (bushings, glands, etc.) that are worn. Lubricate the steering chain and cable and or gears.

Never lubricate Nylon, Ertalon or Teflon bushings, with either oil or grease, use only WD-40.

If you have wheel steering, maintenance should be in accordance with the manufacturer's recommendations.

Make regular checks on all the clamps, the condition of the quadrant, the cables or push rods, guide sheaves and the chain in the column to the wheel.

Make regular checks of the steering end stops to ensure they are adequately stopping the rotation of the rudder, this is important for direct drive push rod systems. Over rotation of the rudder could cause a steering lock up.

INTERIOR WOOD

The internal woodwork used in most of our boats is varnished. This should be regularly rinsed off with fresh water and a little liquid detergent, then polished with a chamois leather.

Should the woodwork become damaged, gently rub it down with very fine sandpaper and touch it with several coats of the varnish. Your dealer will be able to order Beneteau varnish. When this is dry, rub it down with a very fine wet-and-dry sandpaper (grade 800 or 1000) and finish off with polish (or a silicone spray) or wax.

ELECTRICAL SYSTEMS

It is essential for an electrical system to have a battery in sound condition to function properly. The following are some of the things to maintain a battery in the best condition.

- Keep the battery clean and the terminal posts well greased.
- Keep the battery electrolyte checked regularly
- Keep the battery fully charged.

If you have to leave your boat unused for more than a month it is best to leave your batteries with your yard so that they can be kept charged. Keep a suitable charger onboard so you can recharge your batteries at dockside without having to turn on the engine.

If you have an inboard engine, check the condition and tension of the alternator drive belt. From time to time, spray a little WD-40 or something similar on all the connections to the control panel, terminal boxes and lamp sockets. Make sure that cable grommets are watertight; smear them with Vaseline so that they do not dry out and deteriorate.

BATTERY MAINTENANCE

Make sure that the level of the electrolyte is always at least 1/2" above the top of the plates. This level can change suddenly, due to evaporation in an overheated bilge.

WARNING! THE ELECTROLYTE IN A BATTERY IS A SOLUTION OF SULFURIC ACID. IF ANY SHOULD ENTER THE EYES, RINSE IMMEDIATELY WITH LARGE AMOUNTS OF FRESH WATER, AND SEEK MEDICAL ATTENTION. ELECTROLYTE SPILLED ON SKIN SHOULD BE RINSED WELL WITH FRESH WATER. EVEN SMALL AMOUNTS OF ELECTROLYTE SPILLED ON CLOTHING WILL DESTROY THE CLOTHING.

If the level is low, fill the battery with distilled water and nothing else. The level of acidity (i.e. the relative density of the electrolyte) should also be checked from time to time.

CAUTION! USE ONLY PURE DISTILLED WATER TO REPLENISH ELECTROLYTE LEVELS. THE WATER FROM MANY CITY WATER SUPPLY SYSTEMS IS UNSATISFACTORY FOR BATTERY USE.

Keep battery connections clean and tight. A cup full of strong baking soda solution and a toothbrush will clean corrosion from the terminals and neutralize any spilled acid (do not allow any of the solution to enter the battery cells). A coating of petroleum jelly or silicone grease on the battery terminals will inhibit corrosion.

WATER SYSTEM

Check all joints regularly for leaks. Keep the tank(s) filled. If, however, you have to leave the boat unattended for several months, disconnect the water lines, purge them, and rinse them thoroughly with vinegar and water so that they do not form foul-smelling deposits.

Important: If the electric pump continues running when all the taps are closed, switch off the power supply at once and check the water system to find and overcome the leak that is causing this.

Check the thru-hulls, seacocks, connectors and hose clamps regularly. Make sure the seacocks turn freely.

MARINE HEAD

Maintenance consists of regularly pumping the system out with fresh water and leaving the holding tank empty whenever possible.

Check the thru-hulls, seacocks, connectors and hose clamps regularly. Make sure the seacocks turn freely.

ENGINE

Whether maintenance of the power system is to be performed by the owner or delegated to a mechanic, it is the owner who must first initiate any action that is to take place. He must either perform the maintenance or decide to call someone to do the job. A working knowledge of the power system is essential in the first case, and preventive maintenance desirable in the second. The engine manual is, of course, the prime source for engine information and should be consulted, preferably before the fact. The following paragraphs are included as a supplement to cover any required maintenance procedures that are not a part of the engine manual.

We have already stressed the points that are of importance for an engine to keep working properly. It might be added that the engine compartment should be kept scrupulously clean; check for any unusual oil or fuel leaks. Inspect all the electrical connections frequently.

Drain the bowl of the fuel/water separator at regular intervals to lessen the chance of water damage to your engine's fuel system. Keep fuel tanks filled.

Inspect the engine mounts and coupling for loose bolts regularly.

Check the oil and coolant levels everyday.

Check the alternator belt for the correct tension, keep a spare belt on hand.

Check all hoses and fuel lines for leaks regularly.

NOTE: Always have a spare set of sacrificial anodes on board, and regularly check those that are already fitted for deterioration; they should be replaced when their size has been reduced by half. The time this takes will vary with the waters in which the boat is used. Water temperature, salinity, the presence of neighboring boats, the nature of the bottom and the materials in the dock will all affect the life of your boat's anodes.

Order your spare anodes thru your dealer or from Beneteau Customer Service.

CALIFORNIA

Proposition 65 Warning

Diesel engine exhaust and some of its constituents are known to the State of California to cause cancer, birth defects, and other reproductive harm.

SAILS

Check the sails regularly, as the slightest wear in the stitching or at a reinforced part can very quickly have dramatic consequences. Keep a small sail repair kit on board and a book showing how to carry out minor work yourself until you can get the job done by a professional sail maker.

Keep a special eye on points where the sails can chafe on the rigging or fittings - turnbuckles, lifelines, shrouds, spreaders, etc.

Salt water and sunshine take their toll on sails. Whenever possible, rinse the sails in fresh water and leave them stretched out (preferably on a lawn) to dry. Never dry a sail by hoisting it and letting it flog in the wind; this will very quickly cause the sail to deteriorate. Never fold and store a damp sail.

XXIII) WINTERIZING PROCEDURES

The end of the season is a good time for a complete inspection of all of the boat's systems. It is easy to take shortcuts when decommissioning your boat but proper lay-up procedures will ensure trouble free recommissioning in the spring.

The following sections are oriented towards hauling your boat for winter storage in a cold climate, but they are also a good guideline as a lay-up procedure for your Beneteau in any climate.

An improperly winterized boat will lead to costly repairs and extensive delays, we recommend winterization by a competent yard or your Beneteau Dealer. The owner must ensure that the boat is correctly winterized.

HAULING

Your Beneteau should be hauled for inspection and maintenance at least once a year; the frequency of haul-outs may vary due to your local conditions and marine growth. A good boatyard is seasoned in hauling and maneuvering boats on land, you may verify this by checking to see that the weight of the hull is resting firmly on the bottom of the keel and that even contact exists along the bottom of keel. Jack stands, or cradle uprights, are meant to balance the boat and not to support its weight.

BOTTOM

Clean the yacht's bottom of any growth as soon as the boat is hauled. It is generally preferred to wait until spring to paint the bottom. Use the following guidelines when using a pressure washer:

MAXIMUM WATER TEMPERATURE TO BE 70° F. (21° C.)

MAXIMUM PRESSURE TO BE 2175 PSI (150 BARS) AT NO CLOSER THAN 4"

CUTLASS BEARING

The shaft strut contains a rubber type cutlass bearing. At haul out, be sure the bearing slots are clear and apply silicone lubricant or castor oil to the bearing to preserve its suppleness. Replace the cutlass bearing if excessive wear is evident. Be sure to realign the engine if the bearing is replaced. Bleed the prop shaft seal after re-launching

ZINC

Replace the sacrificial zinc before re-launching the boat.

FRESHWATER SYSTEM

This system is best winterized with one of the non-toxic antifreezes available for use in boat and recreational freshwater systems. It is an easy method, which replaces fresh water with a non-toxic antifreeze mixture.

Caution! Be sure to use non-toxic antifreeze.

1. Allow the water in the water heater to cool, and open the pressure release valve on top. Disconnect the hot and cold water hoses and allow the tank to drain either in a bucket or into the bilge. Connect and clamp the hot and cold water hoses together using a short length of 1/2" pipe in order to bypass the heater.
2. Mix the appropriate amounts of antifreeze and water, as directed on the label, to deliver the degree of protection desired. Put 1-1/2 to 2 gallons of the solution into each water tank.
3. Open both tank selector valves on the manifold.
4. Turn on the pump and open all fixtures until antifreeze runs through. Be sure to open the hot water selector valve in order to supply antifreeze to the hot water hoses and through the bypass loop.
5. At this point, the freshwater system should be completely protected by antifreeze against freezing to a degree indicated by the strength of the solution placed into the supply tanks.
6. New boats delivered have their freshwater systems filled with antifreeze as described above, and are protected to -30 degrees F.

HEAD

Several days before completing haul-out procedures, fresh water should be allowed to stand in the head unit to dissolve any salt accumulation in the hoses and pump. Remove all water from the head. Special lubricants for the pump's internal mechanism are available. Check with your marine hardware dealer for a recommended brand. Never put oil, gas, kerosene, or alcohol in the head or they will ruin the internal valve.

Completely pump out all waste from the holding tank and pour in a cleansing, deodorizing solution. If possible, allow this to sit in the tank overnight, then completely pump out and drain the entire system. If antifreeze is used in the system, check in the manufacturer's literature for the recommended type.

ENGINE

Winterization by a marine mechanic is highly recommended to ensure that your engine is properly protected. Consult the Engine Owner's Manual for your specific engine's guidelines for winterizing. Follow the instructions carefully to ensure the engine is adequately protected. The general procedure is to replace raw seawater with an antifreeze solution mixed to protect the engine in your local area and to check the heat exchanger side to ensure that it contains an adequate antifreeze solution as well.

1. Prior to hauling the boat, run the engine to achieve normal operating temperatures in order to open the thermostat.
2. Close the raw water intake thru hull and remove the hose from the valve hose barb.
3. Insert the intake hose in a bucket of antifreeze solution and run the engine briefly until all raw water is flushed thru the exhaust system and only the antifreeze solution is expelled from the exhaust.
4. Be sure the thru hull valve is opened after the boat is hauled.

FUEL SYSTEM

Consult your engine manual to clean any engine mounted fuel filters.

Drain any water from the bottom of the fuel/water separator.

The fuel tank should be kept full for winter storage with about 5% expansion room left at the top. Empty fuel tanks encourage the formation of condensation.

BATTERIES

Clean battery terminals and cable ends thoroughly of any corrosion with a baking soda and water solution, and apply a light protective layer of petroleum jelly.

Batteries should be fully charged before storage, and the fluid level maintained. Store batteries in a warm, dry place. Do not store batteries directly on a stone or cement floor.

SEACOCKS

Open and drain all seacocks after boat is hauled. Open all seacocks for winter storage.

BILGE

Completely pump out bilge of any water and clean out any debris present. Bilge pumps should be pumped dry and hoses disconnected, to ensure that no water is left in the system.

ICEBOX

Remove any remaining food from the icebox and wash down thoroughly with warm water and detergent solution.

Odors can be removed with a baking soda and water solution, and an open box of baking soda left in the icebox will continue to remove odors throughout storage.

Completely pump out any water from the bottom of the icebox and make sure pump is completely dry of any water.

Leave icebox lid open during storage to allow ventilation.

STOVE

Depressurize the gas system and close all valves. Clean stove thoroughly. Remove fuel tanks and clean to remove any salt accumulation from their surface. Wipe down stove and tanks with a rag while applying a light layer of WD-40 or other lightweight, protective oil.

INTERIOR

Remove as much loose gear from the boat as possible and store in a clean dry place. If cushions are left on board be sure they are dry and propped on edge to encourage ventilation.

Rinse and dry all floorboards and store them on their edge to encourage ventilation. Leave all lockers clean and open for ventilation.

COVERING THE BOAT

Cover the boat adequately during storage to prevent excessive weathering.

BE SURE THE COVER DOES NOT CHAFE BOAT.

Ventilation between the winter cover and the boat is required to avoid build up of humidity.

CAUTION! DO NOT USE BLACK POLYETHYLENE AND DO NOT SHRINK-WRAP THE BOAT BY TAPING TO THE HULL. ALWAYS ASSURE GOOD VENTILATION.

SAILS

Remove the sails, clean following the sail makers recommendations and store in a clean dry space.

MAST

The aluminum mast requires a minimum of care and maintenance. At the end of each season it should be washed with a mild detergent and water solution, followed by a complete rinsing with fresh water. Tie off all halyards and lifts, and inspect the mast completely for scratches, cracks or stress marks. Apply paint or a clear lacquer to any scratches found to prevent corrosion. Consult your dealer or a marine rigger if any cracking or stressing of the aluminum tube is found.

Check all hardware on mast carefully for signs of corrosion, and check the tightness of the fastenings. Masthead sheaves should show no signs of wear and should move freely. Lubricate if necessary.

XXIV) ENVIRONMENT

Do not pour oil overboard; use appropriate waste containers.

When you fill up the engine fuel tank, take all the precautions in order to avoid overflowing.

In the harbor, do not use the heads if they are not equipped with holding tanks.

The use of detergent contributes to the deterioration of the sea fauna and flora; choose entirely biodegradable products for your cleaning operations.

Do not throw plastic bags overboard.

You love the sea, just as we do; therefore, help us to protect it and do not pollute it.